

1

2

3

4

A

A

B

B

C

C

D

D

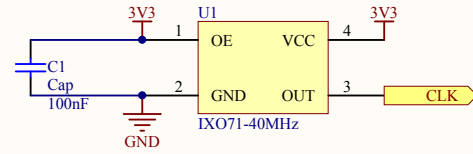

Title		
Size A4	Number	Revision
Date:	15/06/2012	Sheet of
File:	C:\Documents and Settings\...\Clock.SchDoc Drawn By:	

1

2

3

4

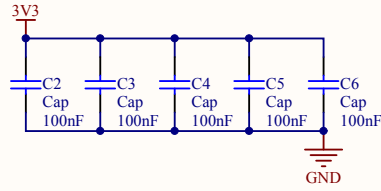
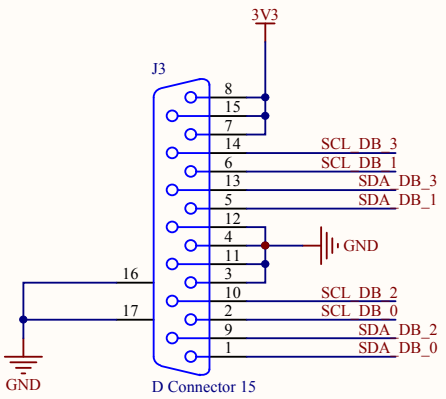
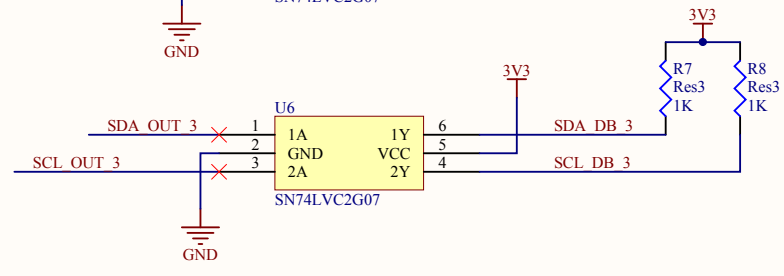
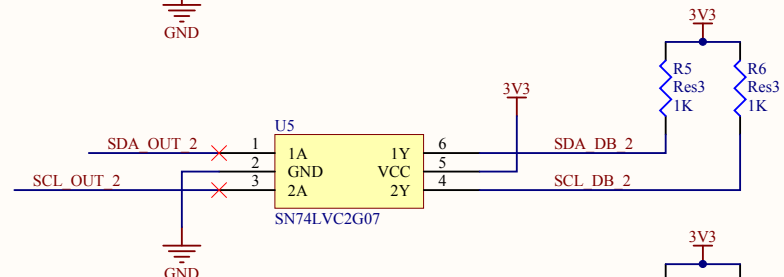
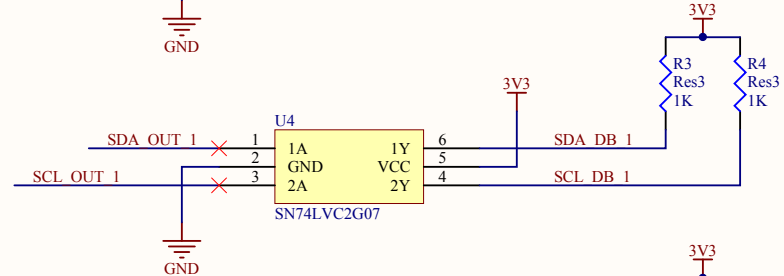
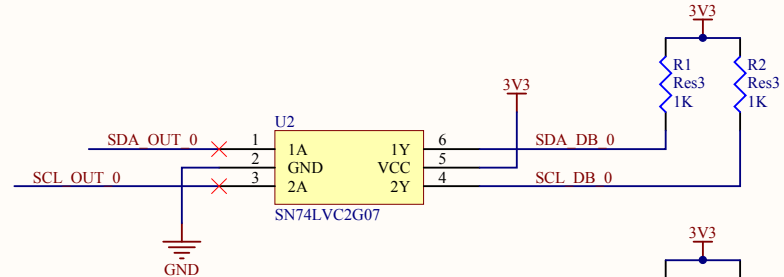
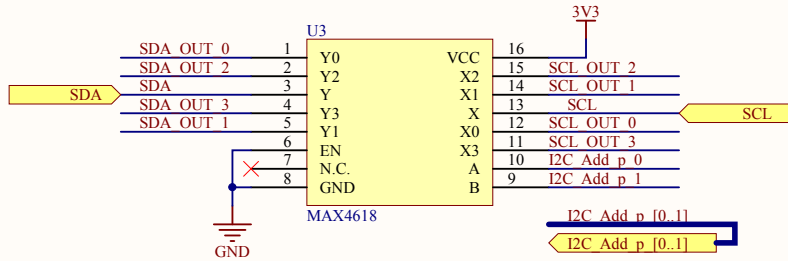

Title		
Size A4	Number	Revision
Date: 15/06/2012	Sheet of	
File: C:\Documents and Settings\...DB25.SchDoc	Drawn By:	

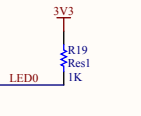
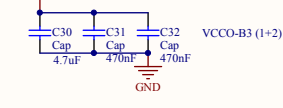
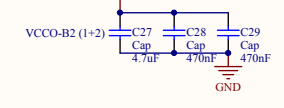
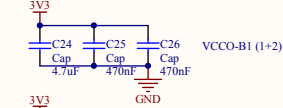
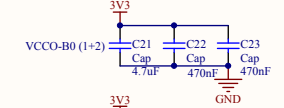
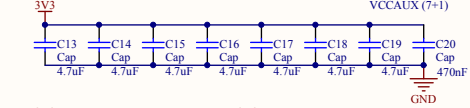
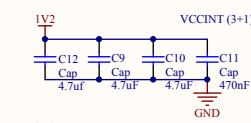
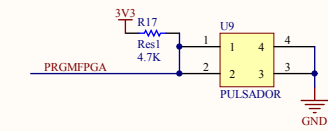
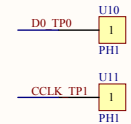
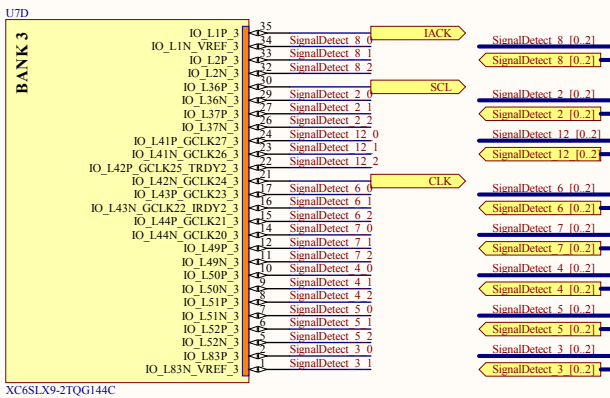
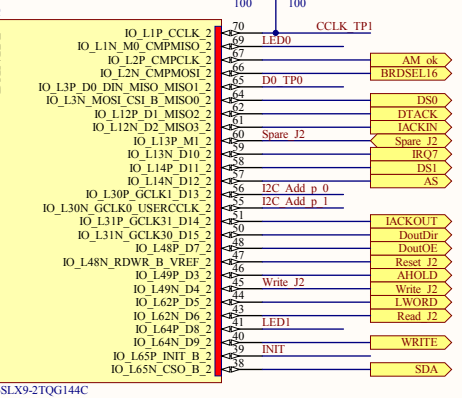
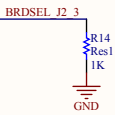
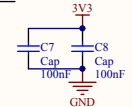
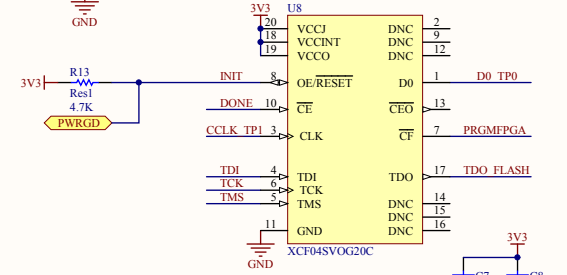
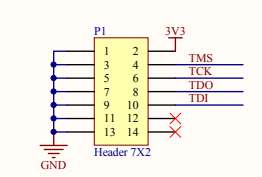
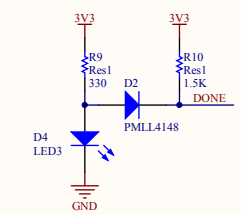
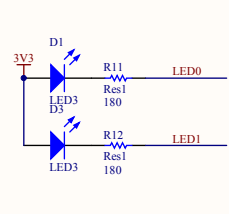
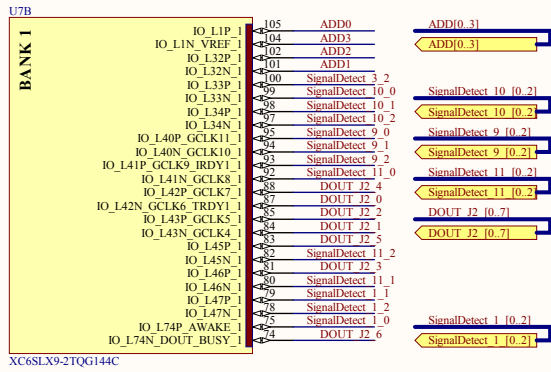
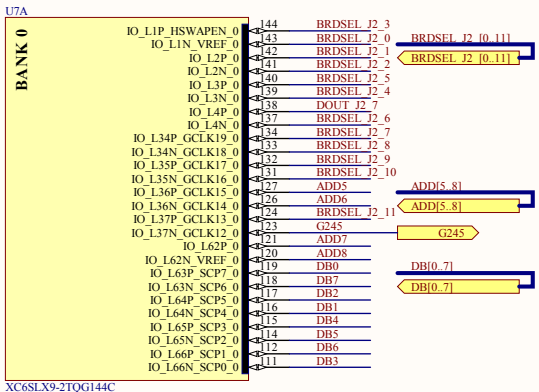

VCCAUX para JTAG interface
VCCO_2 para linea memoria (3.3V)

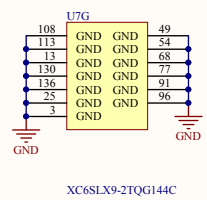
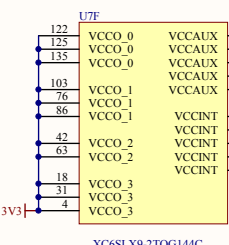
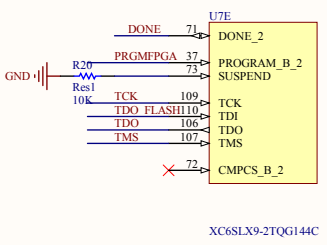

VCCAUX para JTAG interface
VCCO_2 para linea memoria (3.3V)

Title		
OFUCU_FPGA		
Size	Number	Revision
A3		
Date:	15/06/2012	Sheet of
File:	C:\Documents and Settings\... \FPGA.SchDoc	Drawn By:

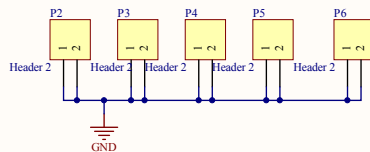
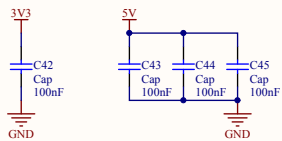
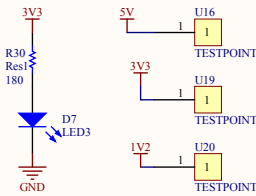
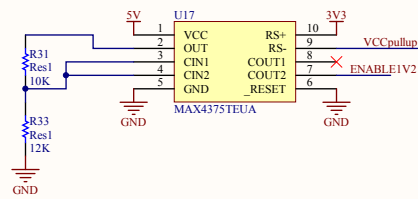
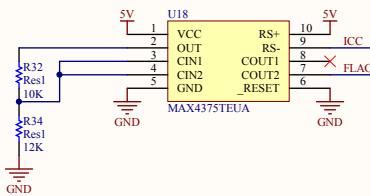
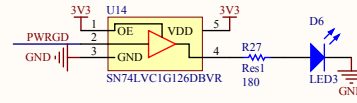
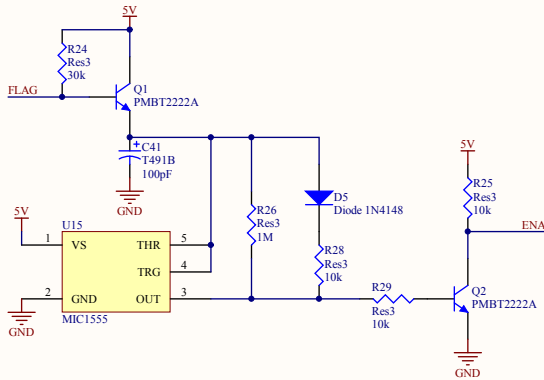
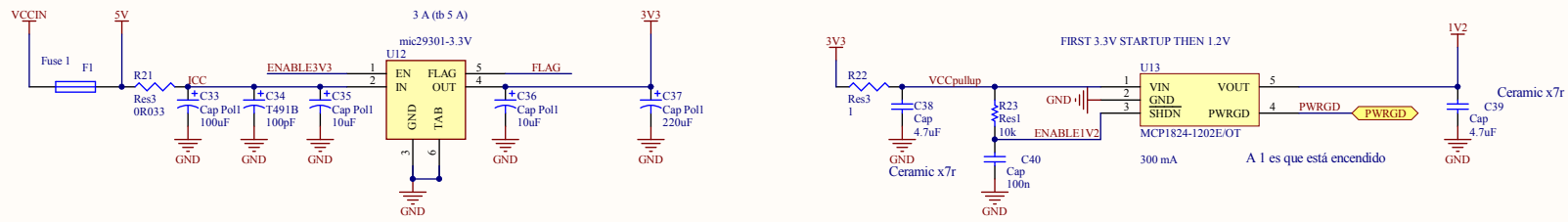

Title		
Size	Number	Revision
A3		
Date:	15/06/2012	Sheet of
File:	C:\Documents and Settings\...Power SchDot Drawn By:	

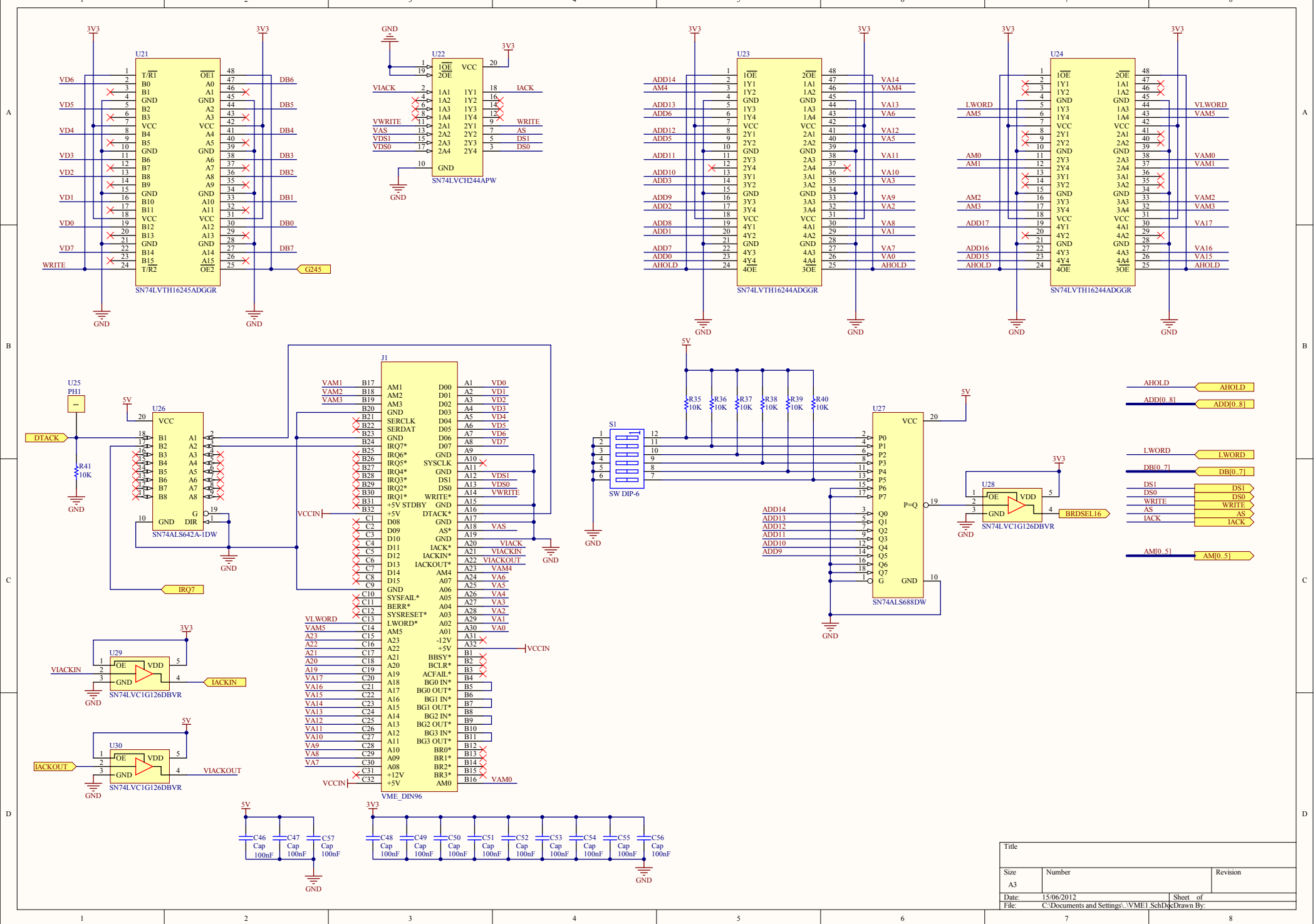

Title		
Size	Number	Revision
A3		
Date:	15/06/2012	Sheet of
File:	C:\Documents and Settings\... \VMEI_SchDd\Drawn By:	

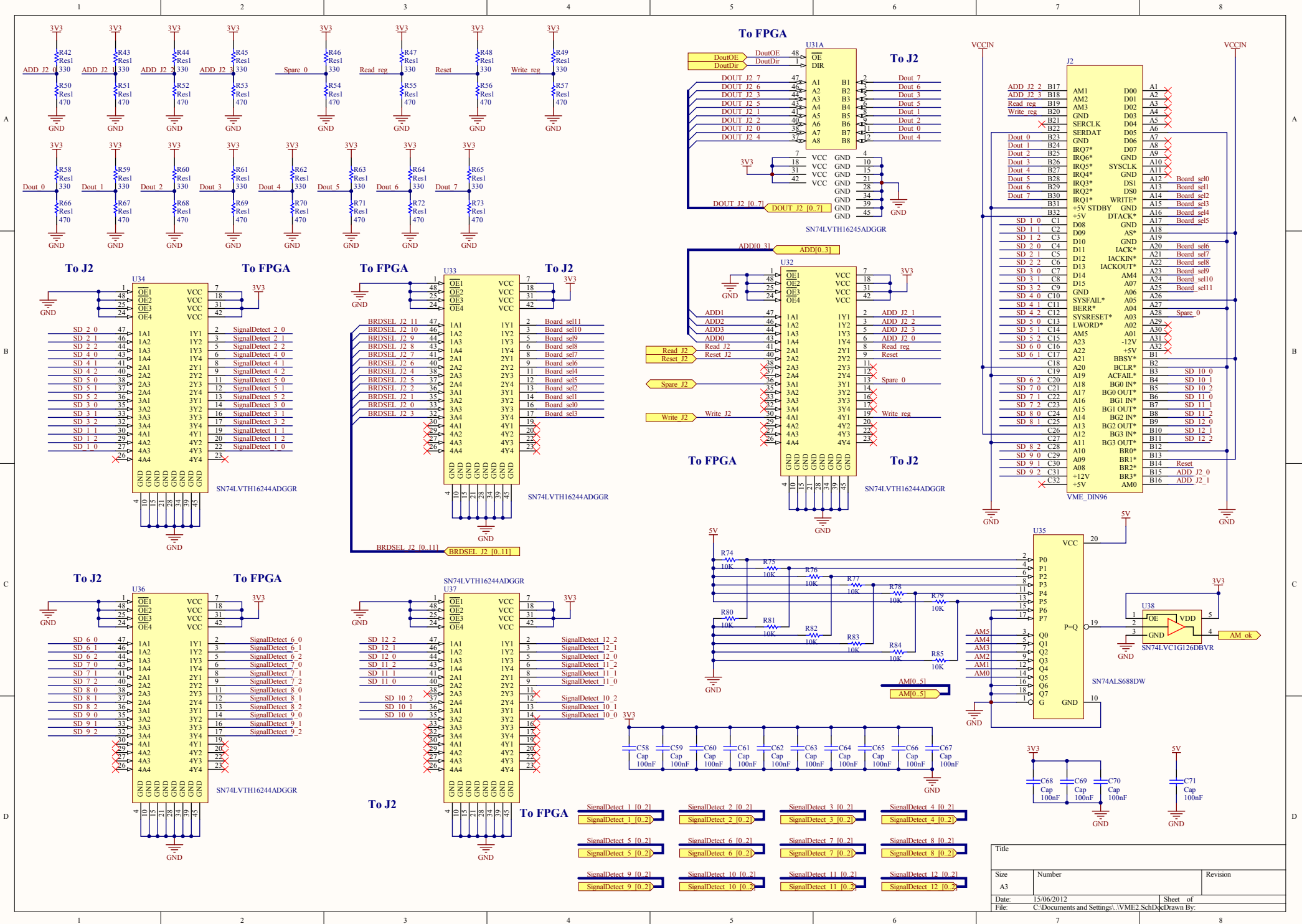

Title		
Size	Number	Revision
A3		
Date:	15/06/2012	Sheet of
File:	C:\Documents and Settings\... \VME2_SchDd\Drawn By:	

