

# Observational Constraints on Dark Energy

Eusebio Sánchez Álvaro

CIEMAT

Seminar at the University of  
Louvaine-La-Neuve,

March 2008

# Outline

- Introduction: Standard model of cosmology ten years after dark energy
- What do we know about dark energy?
- How to describe dark energy. The  $w$  parameter
- Observational probes of dark energy
  - *Supernovae Ia*
  - *Baryon Acoustic Oscillations*
  - *Galaxy clusters counts*
  - *Weak gravitational lensing*
- Current situation
- Future projects and expectations
- The DES project
- The PAU project
- Conclusions

## Introduction

The current standard model of cosmology,  $\Lambda$ CDM, is based on

- **The cosmological principle (homogeneity and isotropy)**
- **General Relativity**
- **Inflation, baryogenesis and physics in the early universe**

**The most shocking consequence is that 96% of the matter-energy content of the universe remains unexplained.**

**Cosmology requires new physics beyond standard model of particle physics to understand dark matter and dark energy.**

**The evidence of dark energy is twofold:**

- Accelerated expansion of the universe, measured from SNIa
- The universe is flat (from CMB) and its matter content is around 24% (from LSS, BAO), ergo, “something else” must provide the missing mass-energy. Remarkably, the same “dark energy” can also explain the accelerated expansion.

# Introduction

From CMB  $\rightarrow \Omega_{\text{TOT}} \sim 1$  (WMAP and others)

From BBN + CMB  $\rightarrow \Omega_{\text{M}} \sim 0.04 \rightarrow$   
Most of the universe is non-baryonic

LSS (galaxy surveys) + DYNAMICS (rotation curves of galaxies, cluster masses, gravitational lensing)  $\rightarrow$  DARK MATTER!!!! ;  $\Omega_{\text{DM}} \sim 0.22$

Supernovae Ia  $\rightarrow$  DARK ENERGY!!!! ;  $\Omega_{\text{DE}} \sim 0.76$

Universe also contains radiation (CMB)  $\rightarrow \Omega_{\text{R}} h^2 \sim 2.56 \times 10^{-5}$

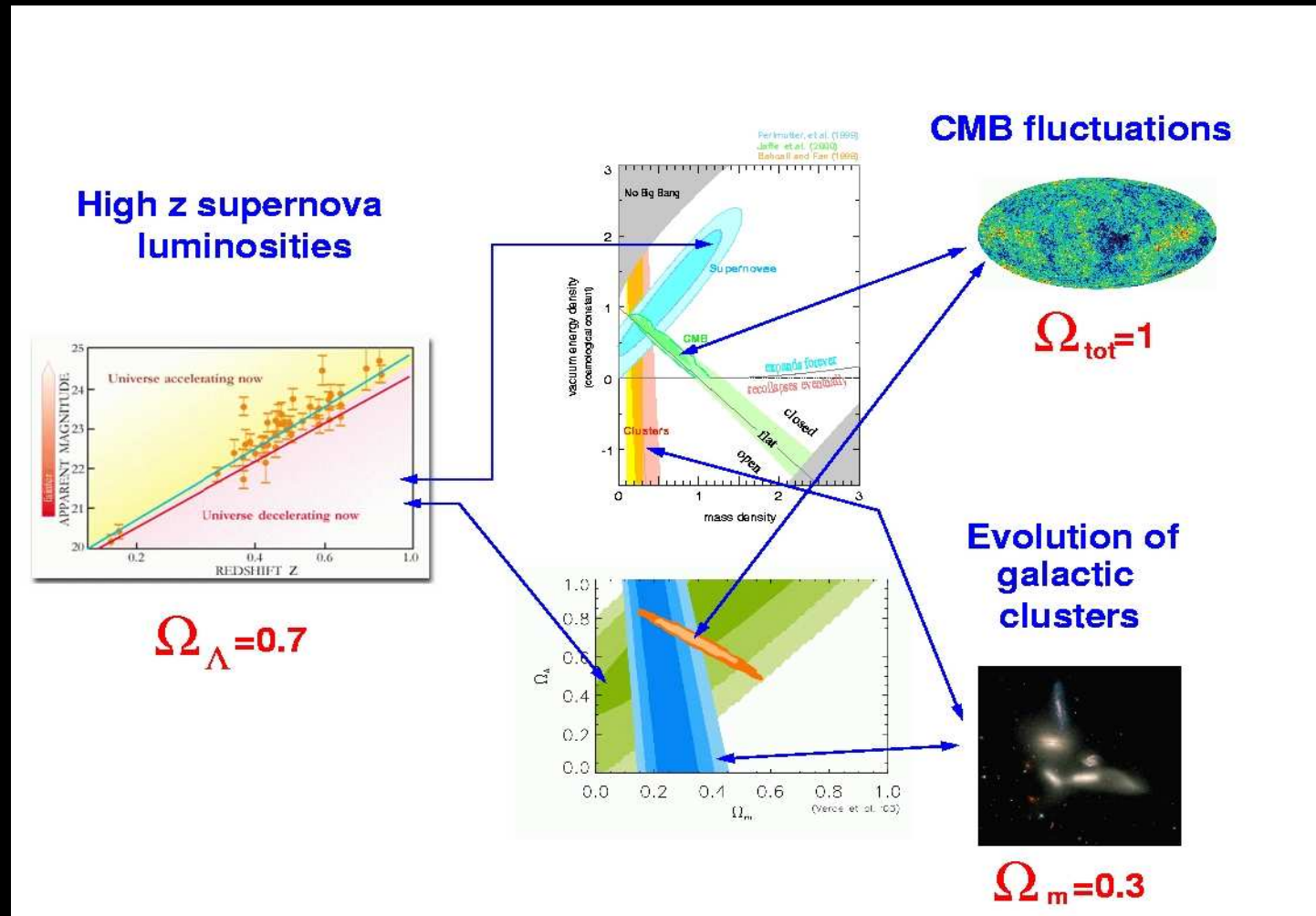

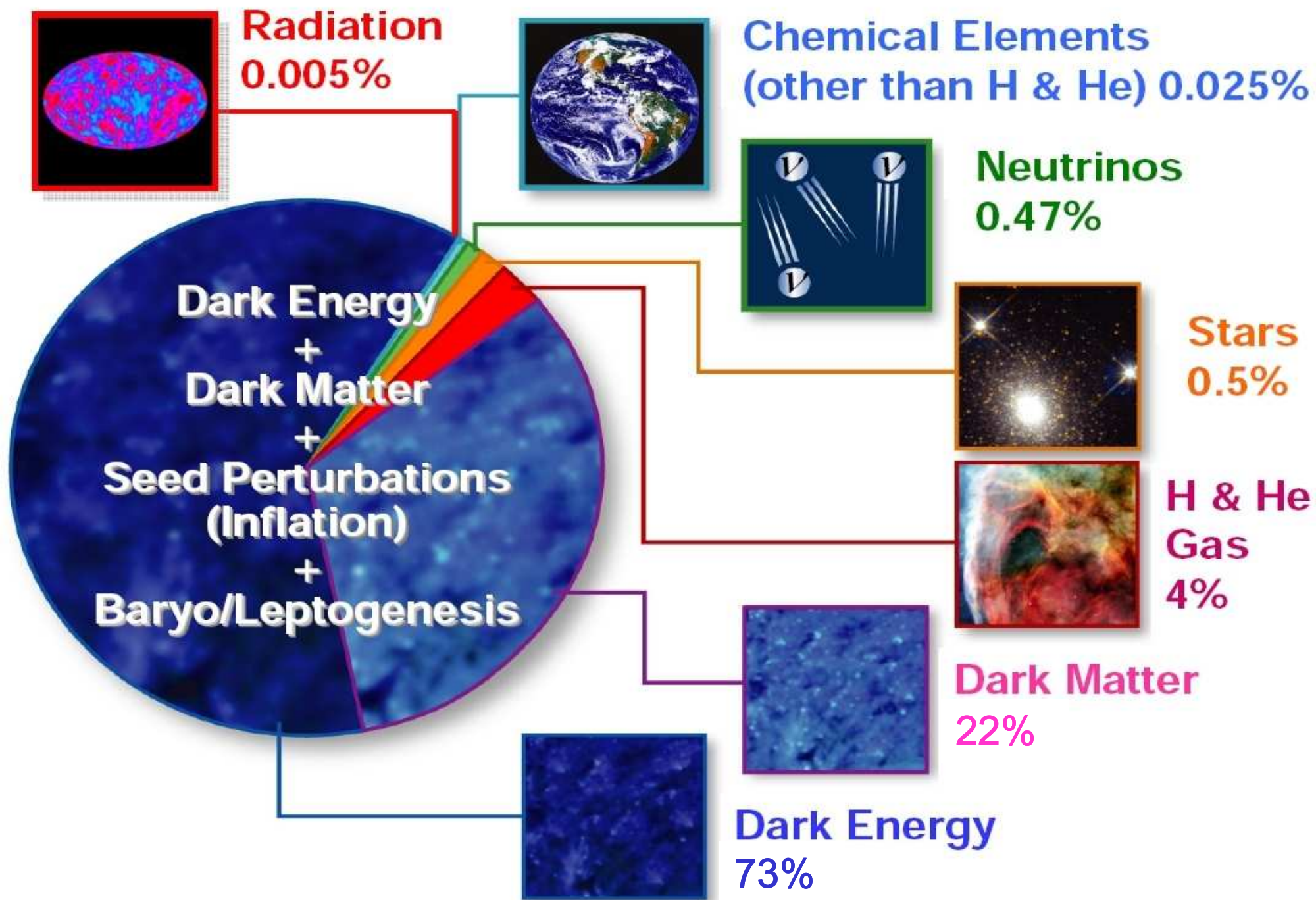



# Dark Matter and Dark Energy

**There is no direct laboratory evidence of nearly 96% of the matter-energy content of the universe!!! Since the baryogenesis is not well understood, even  $\Omega_B$  is not understood.**

MAGIC



There is a strong experimental effort to look for dark matter in the laboratory (accelerators: LHC, non-accelerator: underground experiments, astroparticle physics). There is the hope that particle physics can offer also some hints on the inflation mechanism.

**I will not talk about these topics today**

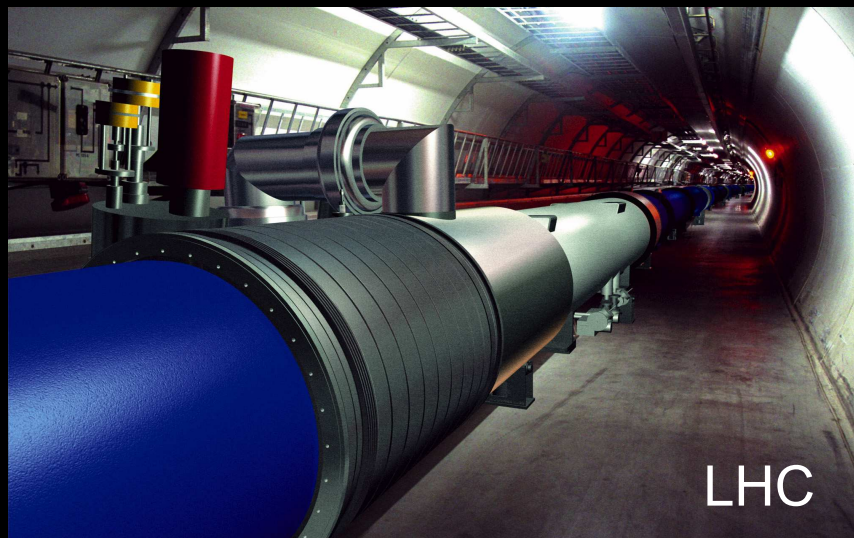

LHC

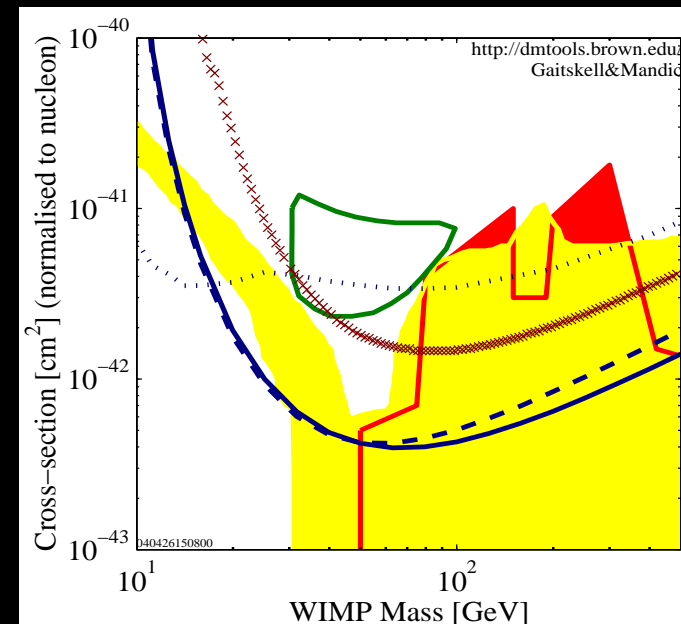

**But... WHAT ABOUT DARK ENERGY???**

## WHAT DO WE KNOW ABOUT DARK ENERGY?

- 1) It emits no electromagnetic radiation**
- 2) It has large and negative pressure**
- 3) Its distribution is homogeneous. Dark energy does not cluster significantly with matter on scales at least as large as galaxy clusters**

Dark energy is qualitatively very different from dark matter. Its pressure is comparable in magnitude to its energy density (it is energy-like) while matter is characterized by a negligible pressure

Dark energy is a diffuse, very weakly interacting with matter and very low energy phenomenon. Therefore, it will be very hard to produce it in accelerators. As it is not found in galaxies or clusters of galaxies, the whole universe is the natural (and perhaps the only one) laboratory to study dark energy.

*No well-motivated theoretical explanations for dark energy*

*Very likely, progress will come from improving observational constraints*

## Many proposed ideas about the nature of the dark energy

Many theoretical proposals for dark energy. Not all of them independent of each other:

**Cosmological Constant**

**Quintessence and its variants**

**(spintessence, k-essence...)**

**Cardassian expansion**

**Modified gravity**

**Inhomogeneous cosmologies**

**Chaplygin gas**

...

**No one is really**

**well-motivated**

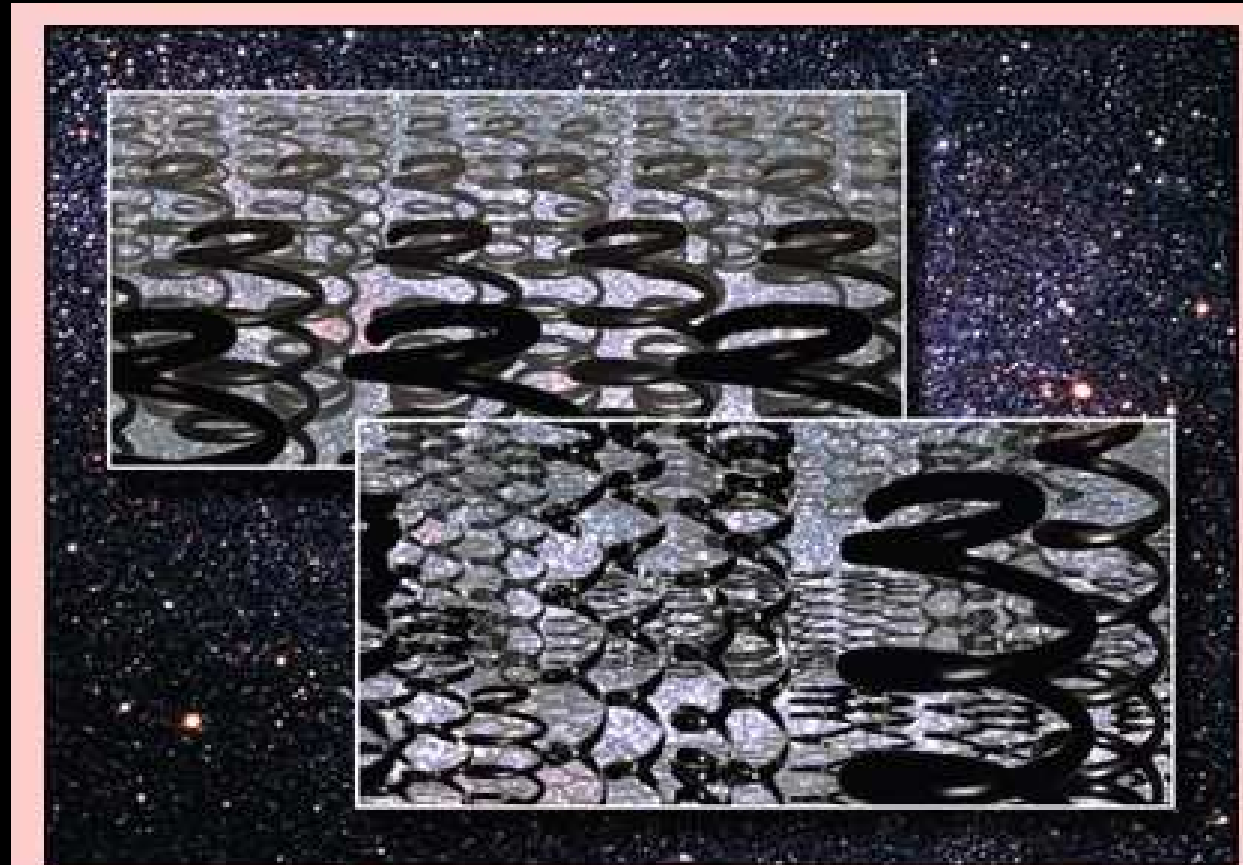

Dark energy is an exotic repulsive force that could make up as much as three-quarters of the cosmos. Possibilities include a cosmological constant or dynamical quintessence, both of which can be represented by scalar fields, like a field of springs covering every point in space. For a cosmological constant (left), each spring would be the same length and motionless. For quintessence (right), each spring would be stretched to a different length.

NY Times



## How to describe Dark Energy: The Equation of State

A phenomenological way to parametrise the dark energy properties: Use the parameter  $w$  of the equation of state.

$$w = p/\rho$$

Main features to be tested observationally: **Is  $w = -1$ ? Is  $dw/dz$  not null?**

From M. Turner astro-ph/0108103			
$\omega_X = p_X/\rho_X$			
Candidate	$\omega$	$d\omega/dz$	
Cosmological Constant	-1	0	
Rolling Scalar Field (Quintessence)	-1 $\rightarrow$ 1	$\frac{1/2\dot{\phi}^2 - V(\phi)}{1/2\dot{\phi}^2 + V(\phi)}$	
False Vacuum State	-1	$\sim 0$	
Topological Defects (N=1 strings...)	-N/3	$\sim 0$	
Others	?	?	

DETF parametrizes  $w(z) = w_0 + w_a(1-a)$ ;  
 $a(t) = \text{scale factor} = D(t)/D(0)$

The DETF figure-of-merit is the reciprocal of the area of the error ellipse enclosing the 95% confidence limit in the  $w_0$ - $w_a$  plane. Larger figure-of-merit indicates greater accuracy.

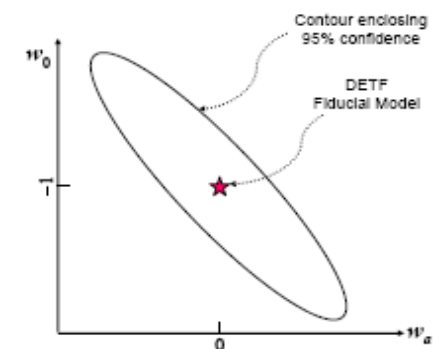

The DETF figure of merit is defined as the reciprocal of the area of the error ellipse in the  $w_0$ - $w_a$  plane that encloses the 95% C.L. contour. (We show in the Technical Appendix that the area enclosed in the  $w_0$ - $w_a$  plane is the same as the area enclosed in the  $w_p$ - $w_a$  plane.)

## Observational Probes of Dark energy

There are several ways of testing observationally the properties of the dark energy. All of them are integrals of the Hubble constant:

Hubble const.   radiation   matter   curvature   dark energy

$$H^2(z) = H_0^2 \left[ \Omega_R (1+z)^4 + \Omega_M (1+z)^3 + (1 - \Omega_{\text{TOTAL}})(1+z)^2 + \Omega_w (1+z)^{3(1+w)} \right]$$

$$r(z) = sn \left( \int_0^z \frac{dz'}{H(z')} \right) \quad \text{with} \quad sn(x) = \begin{cases} k^{-1/2} \sin(k^{-1/2} x) & k > 0 \\ x & k = 0 \\ (-k)^{-1/2} \sinh((-k)^{-1/2} x) & k < 0 \end{cases}$$

Standard Candles: Measure  $d_L = (1+z) r(z)$

Standard Rulers: Measure  $d_A = r(z)/(1+z)$

Number Counts: Measure  $dV/dz d\Omega = r^2(z)/\sqrt{(1-k r^2(z))}$

Growth of structure: A more complicated function of  $H(z)$

# Observational Probes of Dark energy

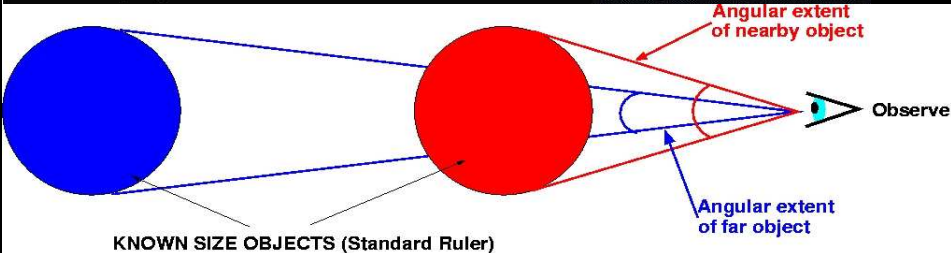
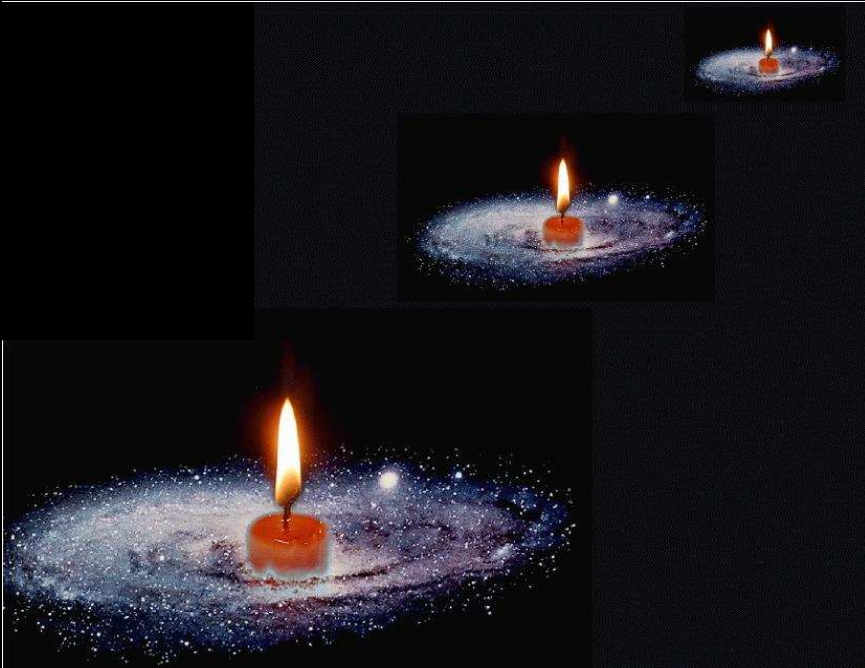

**Try to identify the nature of the dark energy measuring the  $w$  parameter as a function of the redshift.**

**It is necessary to measure with precision, since the differences among different models are small.**

**Control systematic errors!!!!**

## What-If Scenarios

If the universe had more dark energy in it, it would look radically different. Cosmic acceleration would have started sooner, pulled material apart faster and nipped the formation of large structures in the bud. The converse would happen if the universe had less dark energy. Each box below shows a region

that is now one billion light-years across and contains 27 million particles, each representing a galaxy. These simulations assume that the dark energy density is constant in space and time. The quantity  $\Omega_\Lambda$  is the governing cosmological parameter; it represents the density of dark energy today.

### MORE DARK ENERGY $\Omega_\Lambda = 0.99$



### OBSERVED AMOUNT OF DARK ENERGY $\Omega_\Lambda = 0.75$

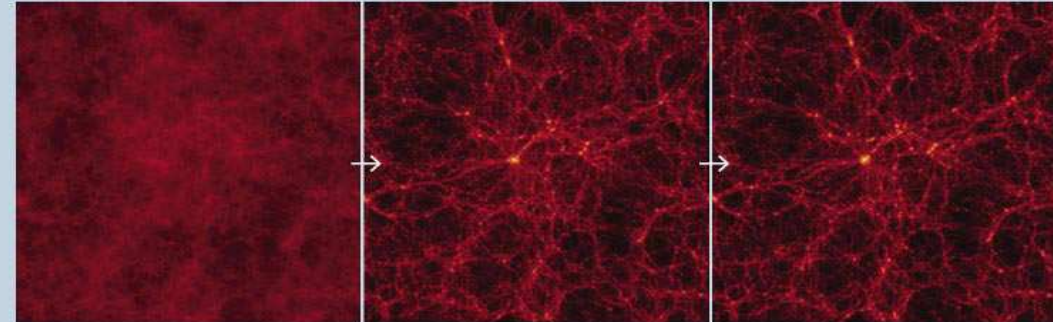

### NO DARK ENERGY $\Omega_\Lambda = 0$

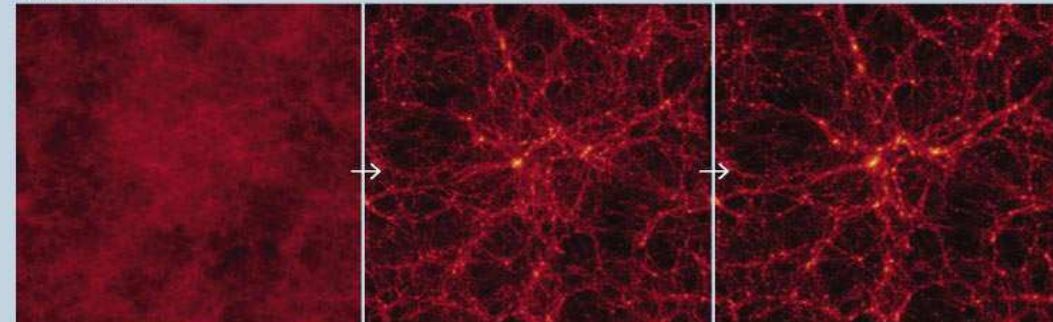

**EARLY UNIVERSE:** When the universe is a sixth of its current size, matter is evenly distributed in all three scenarios. Dark energy has not yet exerted its influence.

**TRANSITION PERIOD:** When the universe is 75 percent of its current size, the effects of dark energy are stark. In the high dark energy scenario [top], the universe looks amorphous. In the other two scenarios, structure formation still continues, producing a cobweb pattern.

**TODAY:** In a universe with the observed amount of dark energy [middle], large-scale structure formation has ended, leaving the cobweb frozen in place. In a zero dark energy scenario [bottom], the cobweb continues to develop.



## Observational Probes of Dark energy

The practical implementation of those observables can be done in many ways:

Distance probes: CMB acoustic peaks, SNIa, BAO, SZ+X-ray+Optical clusters, strong lensing statistics, Ly-alpha forest correlations, Alcock-Pazynski test, galaxy counts...

Growth of structure probes: CMB, weak lensing, galaxy clusters, Ly-alpha forest, ISW effect, ...

Many tests to attack the problem of dark energy, with different sensitivities, different systematics and different levels of practical difficulty.

A full study of all the methods has been done by the DETF. The main conclusion is that the study of dark energy must be done using multiple techniques.

**No single technique is sufficiently powerful to improve the knowledge of dark energy at the level of one order of magnitude.**

**Combinations of techniques: substantially more statistical power, much more ability to discriminate among dark energy models, and more robustness to systematic errors than any single technique.**

**Also, the confirmation of results from any single method**

# Observational Probes of Dark energy

Four methods are identified by the DETF as the most promising:

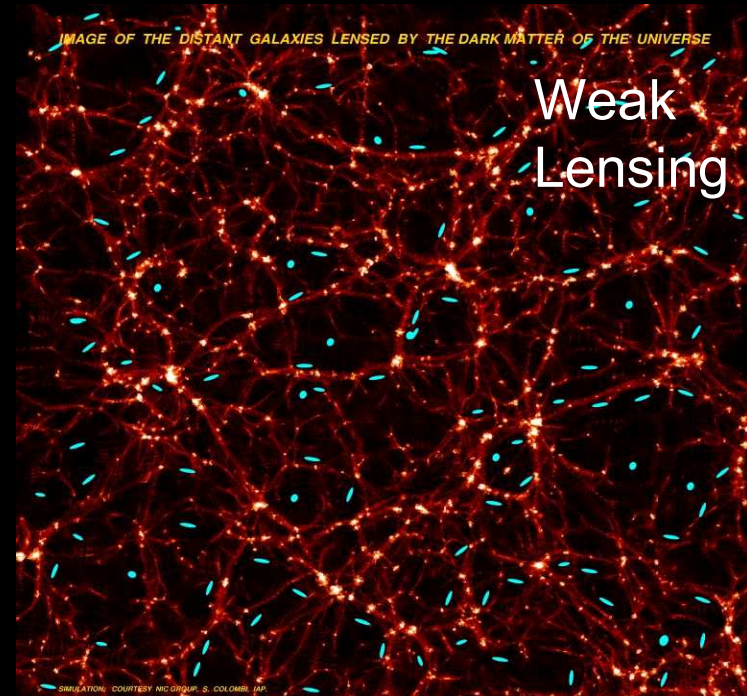
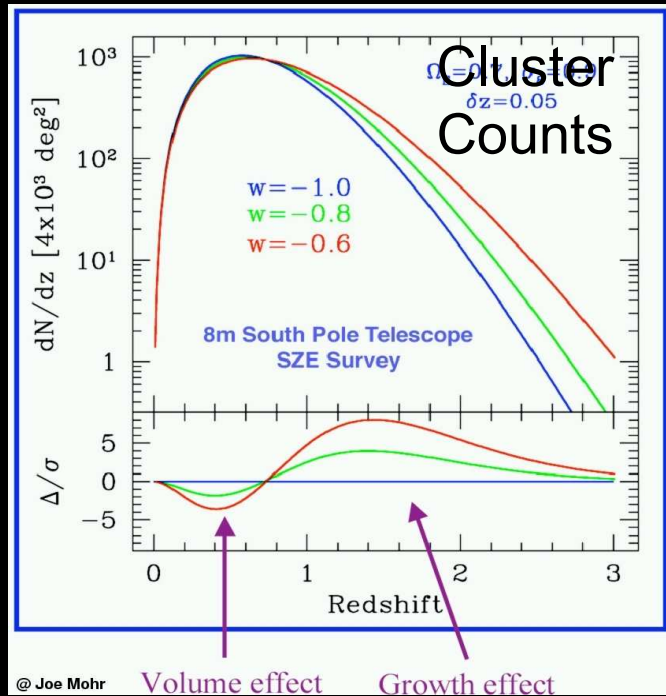
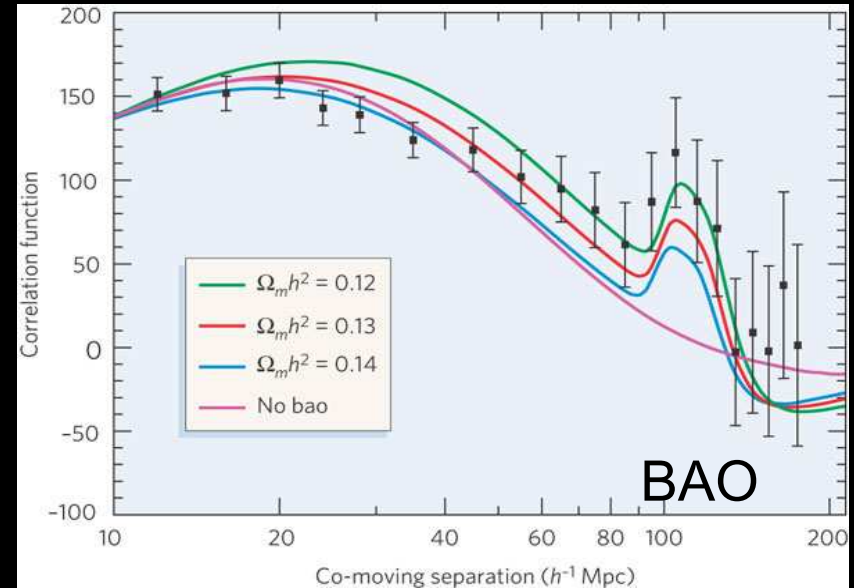
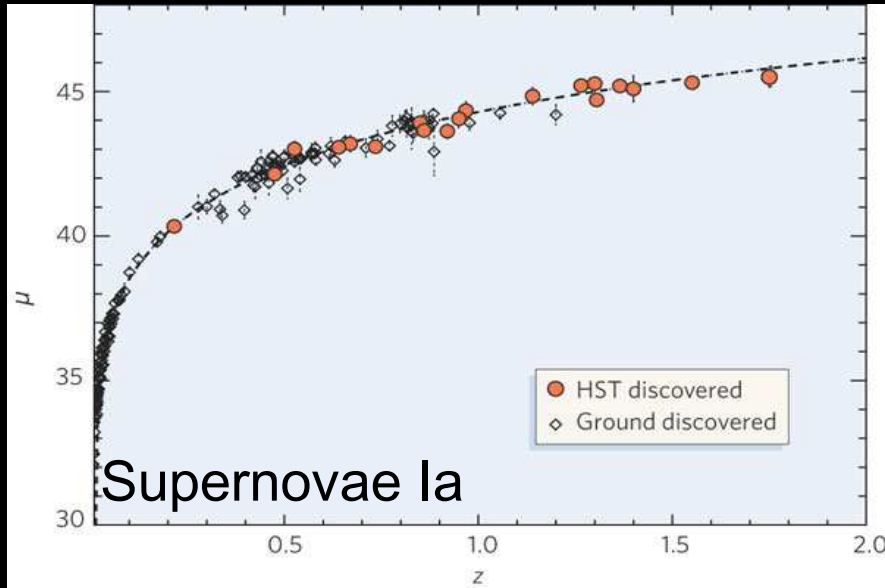



# Supernovae Ia

This is the technique that allowed the discovery of the dark energy.

The most mature technique to date

**SN Ia are GOOD DISTANCE INDICATORS**

## Search Strategy Perlmutter et al. (1995)

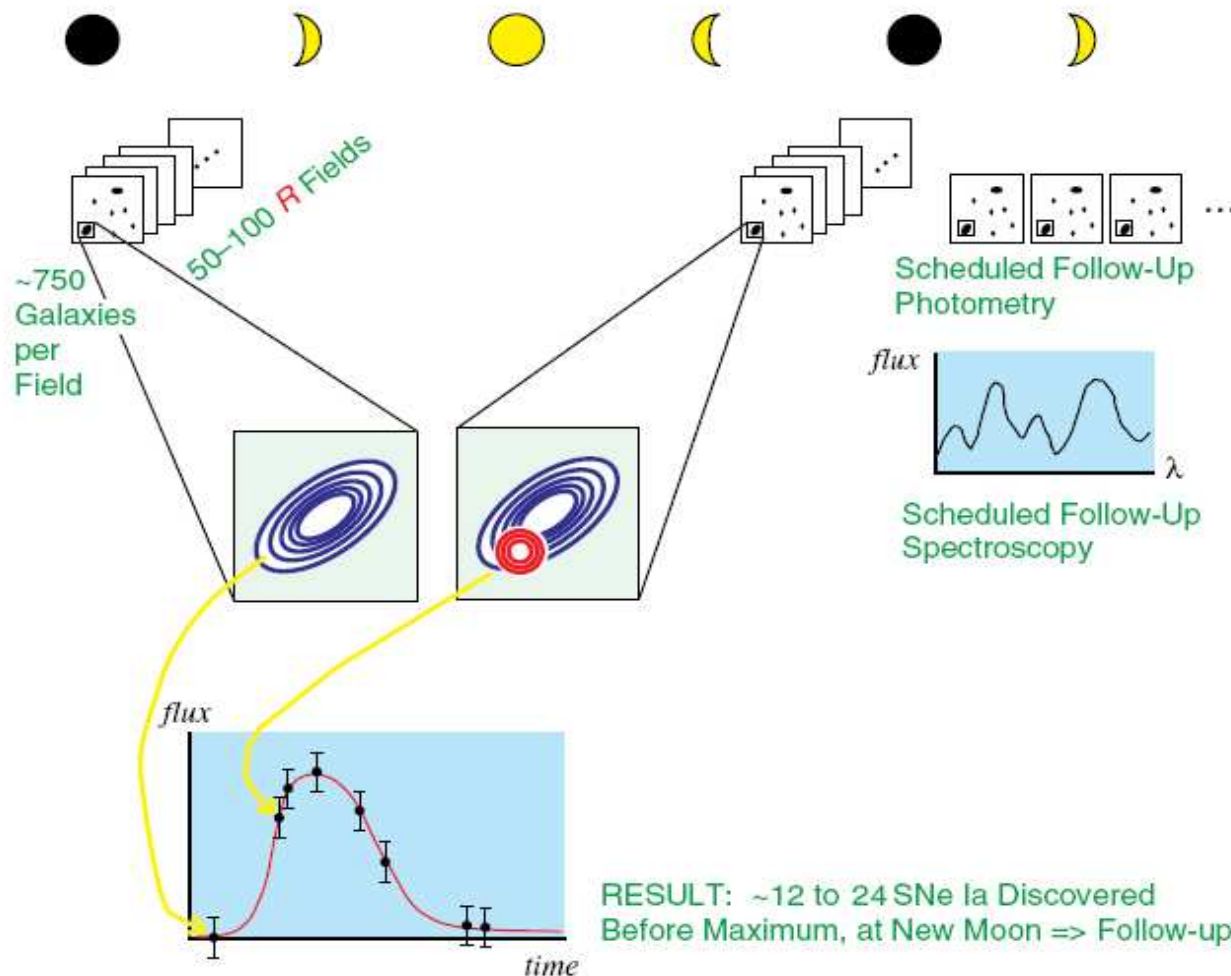

## Search strategy

- Rolling search
- Look systematically to the same part of the sky

## Classification

- Obtain spectra and colors of all the supernovae

## Obtain the light curves

- In many colors

# Supernovae Ia

## SN Ia are GOOD DISTANCE INDICATORS

Not standard candles, but standardizable

Calibrated using nearby sne, cepheids and phenomenological models

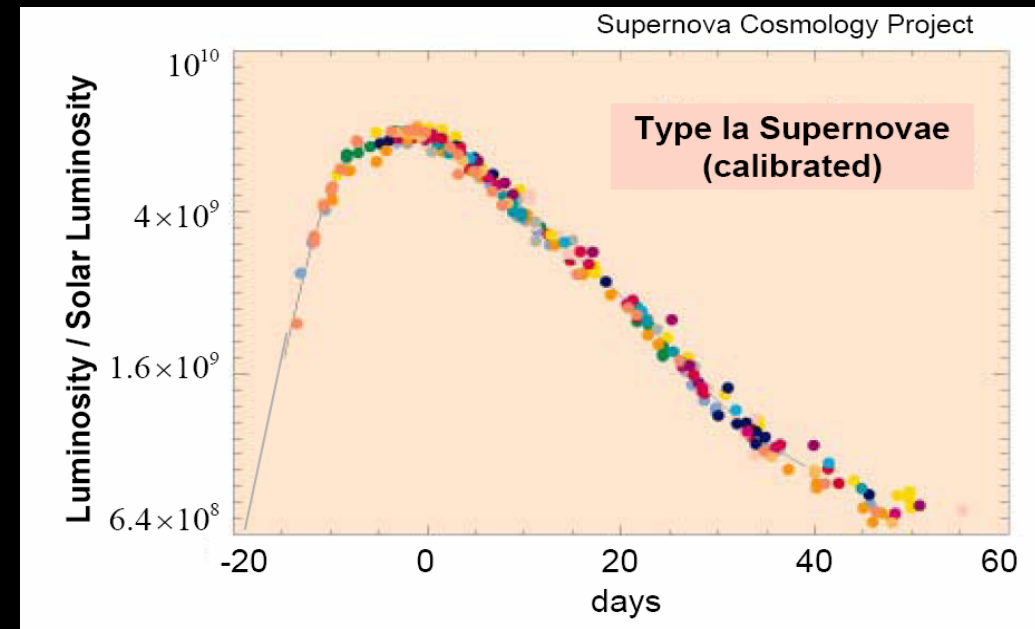
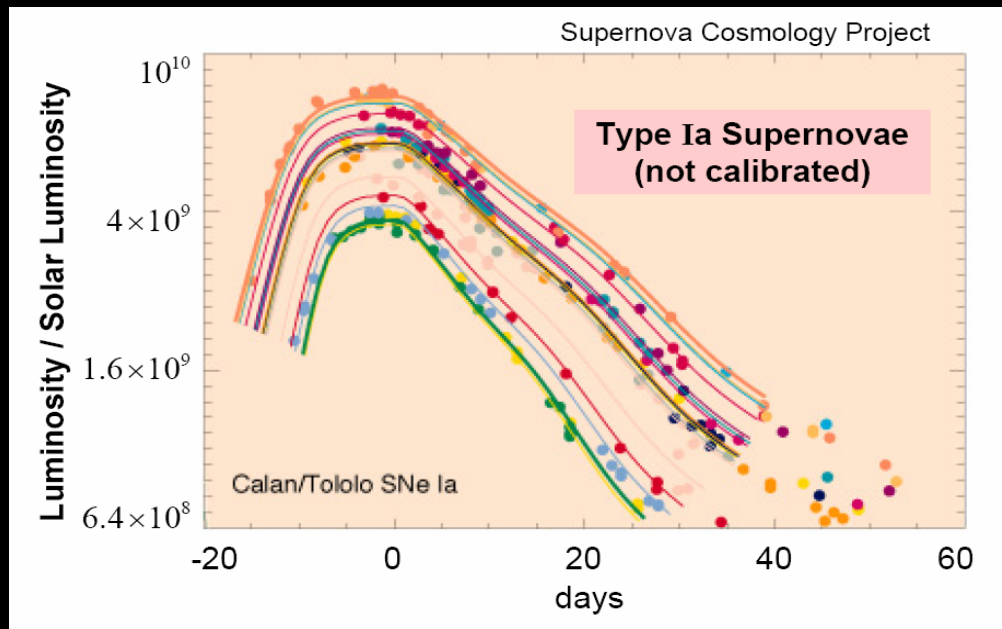

Relate light curve shape to luminosity: Several precise phenomenological models have been developed, SALT2, MLCS2k2. More precise than the initial corrections  $\Delta m_{15}$  or the stretch factor.

# Supernovae Ia

Once the luminosities are obtained, build the Hubble diagram

$$\mu = m - M = 5 \log_{10}(d_L / 10 \text{ pc}) \rightarrow \text{distance modulus}$$

and fit the cosmological parameters using a chi-square

$$\chi^2 = \sum_{\text{objects}} \frac{(\mu - 5 \log_{10}(d_L(\theta, z) / 10 \text{ pc}))^2}{\sigma^2}$$

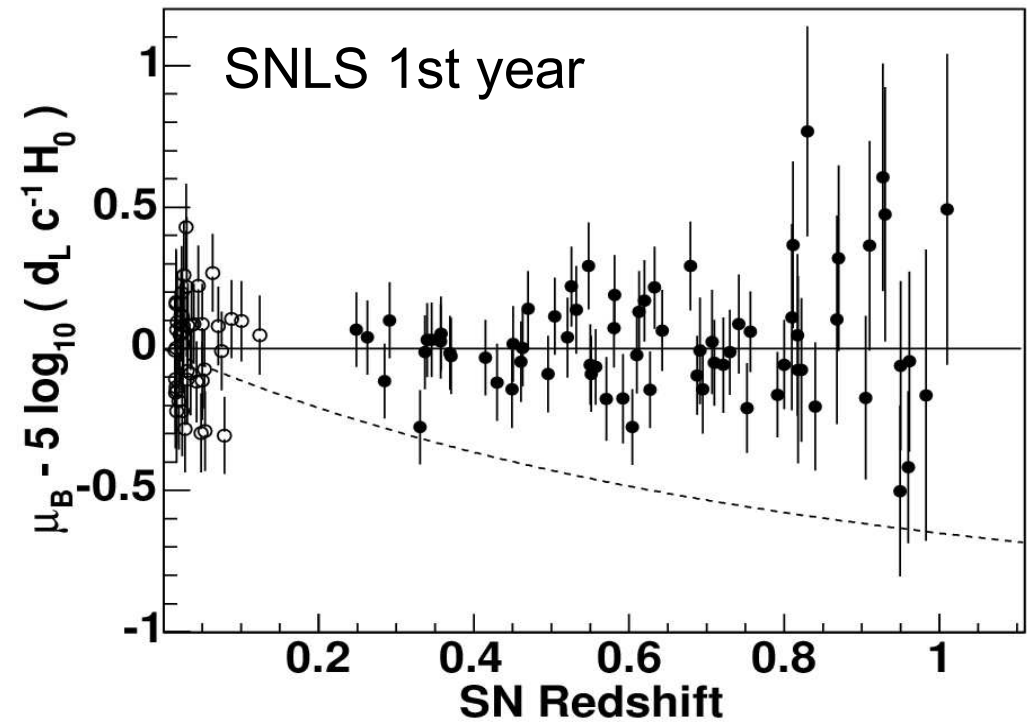
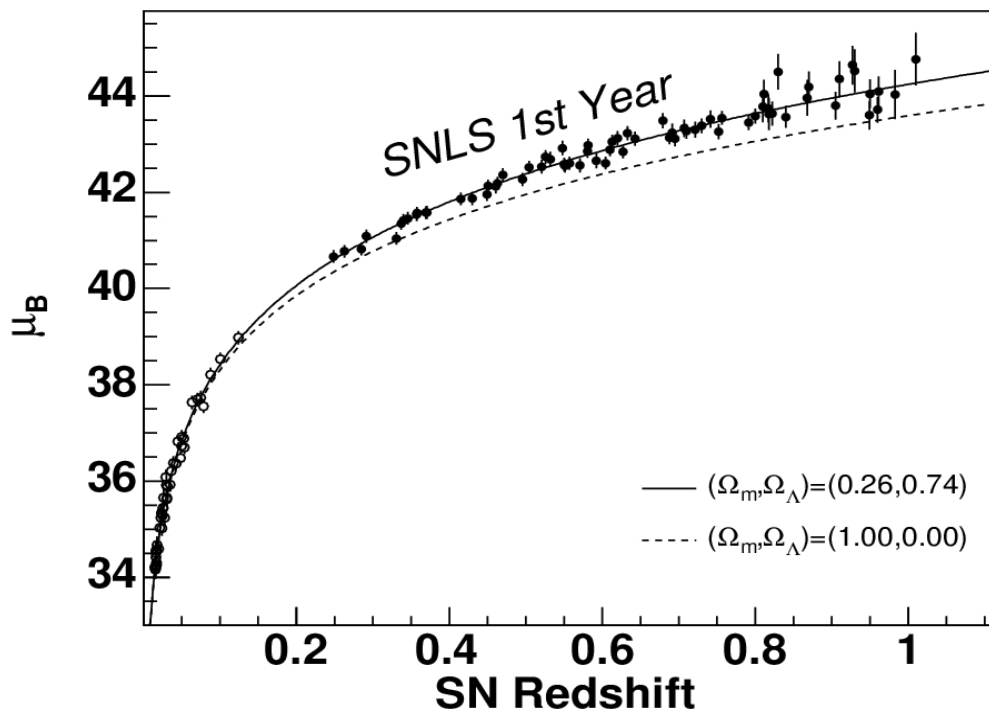

## Supernovae Ia: Systematics

- **Dust:** Normal or grey: Distant sne may be more (or less) dimmed by dust
- **Evolution:** Supernova properties may depend on time. Fit as many hubble diagrams as there are types of galaxies
- **Selection biases and k-correction**
- **Calibration and extinction:** More nearby supernovae, Dust and intrinsic colors
- **Contamination**
- **Gravitational lensing**

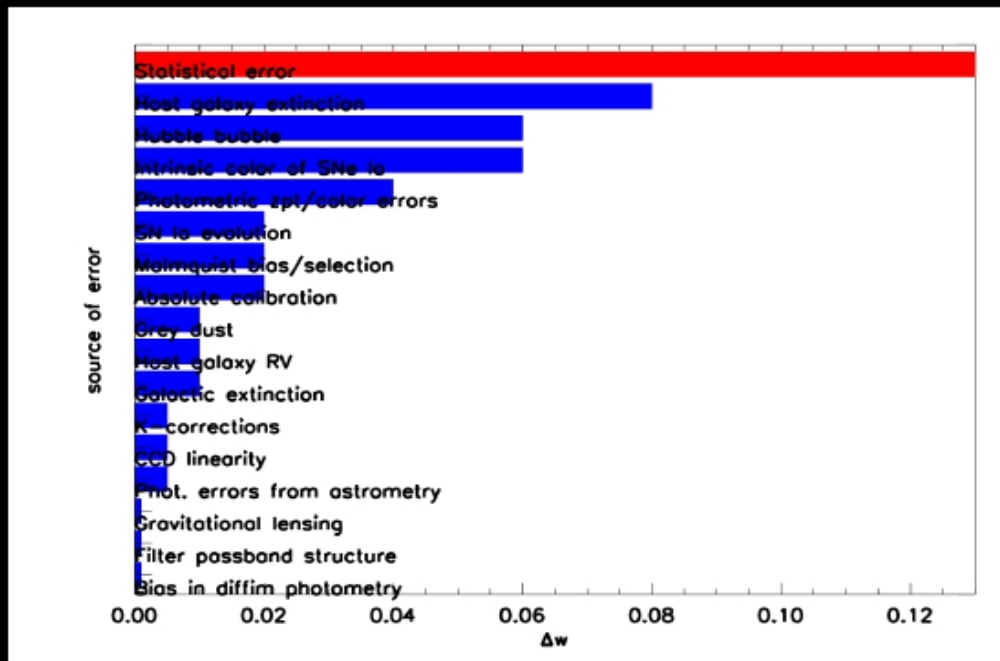

ESSENCE

**Table 6.** Summary of uncertainties in the derived cosmological parameters. The dominant systematic uncertainty arises from the photometric calibration, itself dominated by the  $i_M$  and  $z_M$  band contributions.

Source	$\sigma(\Omega_M)$	$\sigma(\Omega_{tot})$	$\sigma(w)$	$\sigma(\Omega_M)$	$\sigma(w)$
	(flat)			(with BAO)	
Zero-points	0.024	0.51	0.05	0.004	0.040
Vega spectrum	0.012	0.02	0.03	0.003	0.024
Filter bandpasses	0.007	0.01	0.02	0.002	0.013
Malmquist bias	0.016	0.22	0.03	0.004	0.025
Sum (sys)	0.032	0.55	0.07	0.007	0.054
Meas. errors	0.037	0.52	0.09	0.020	0.087
$U - B$ color (stat)	0.020	0.10	0.05	0.003	0.021
Sum (stat)	0.042	0.53	0.10	0.021	0.090

SNLS

## Baryon Acoustic Oscillations

- **Each initial overdensity (in DM & baryons) is an overpressure that launches a spherical sound wave (at 57% of the speed of light).**
- **Photons, that provided the pressure, decouple at recombination.**
- **Sound speed drops very sharply and waves got frozen at a radius of 150 Mpc.**
- **An overdensity in baryons at 150 Mpc and at the origin (DM) both seed the formation of galaxies. More galaxies separated by this distance.**
- The scale of the acoustic oscillations depends on  $\Omega_M$  and  $\Omega_B$ .
- The CMB anisotropies measure these quantities and fix the oscillation scale at a redshift of  $\sim 1100$ .
- In a redshift survey, we can measure this scale both along the line of sight and perpendicular to the line of sight. These measurements give  $H(z)$  and  $DA(z)$  respectively!



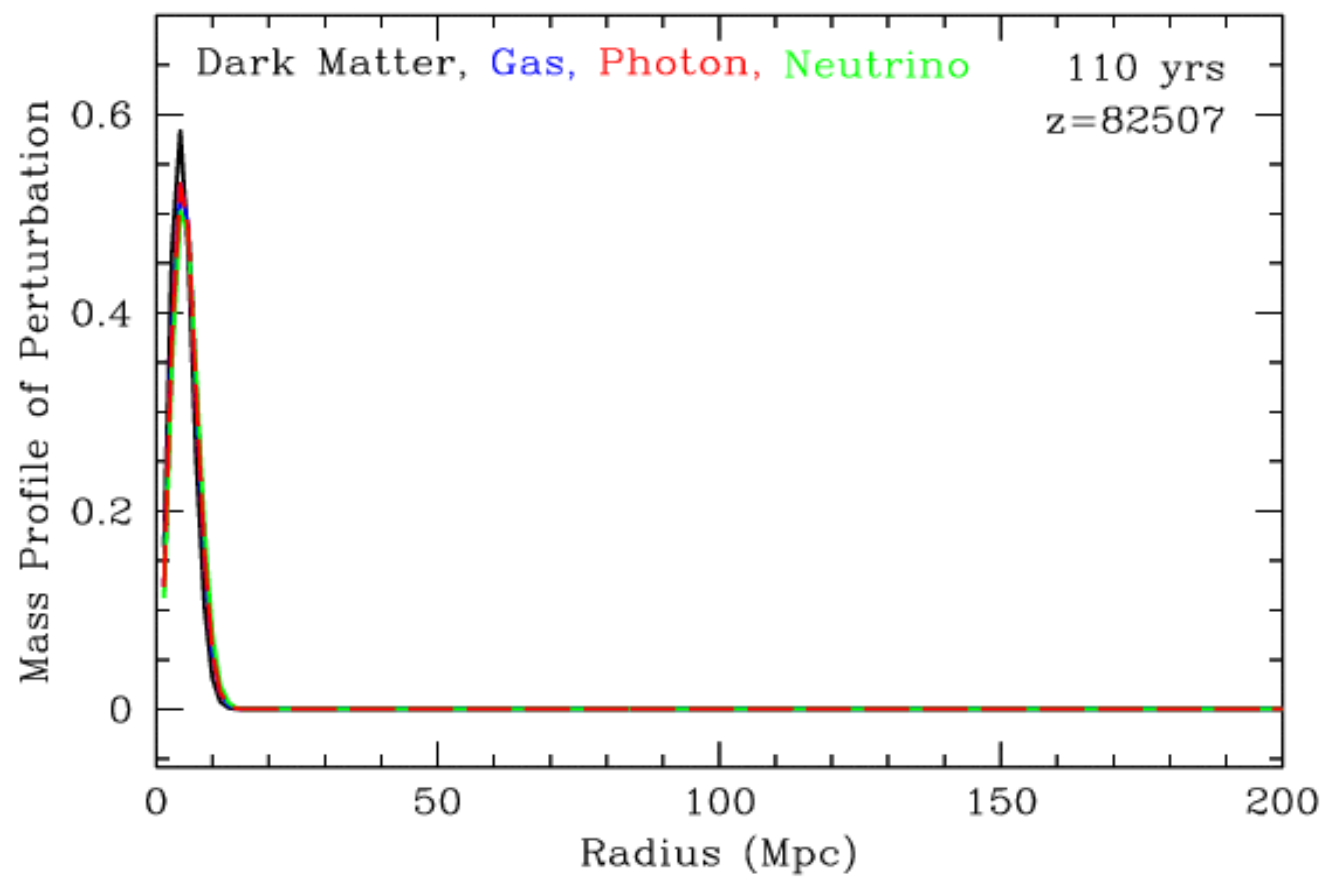

From M. White

## Baryon Acoustic Oscillations

Measure the position and redshift of galaxies and compute the correlation function (or the power spectrum).

**This is an emerging technique, very recently probed (partially) in SDSS. Less affected by systematic errors than the other probes of dark energy.**

Measured transverse to the LOS. At  $z \sim 0.35$ , the measured BAO scale is 148 Mpc, and the effect is detected at  $3.4 \sigma$

Along LOS this technique gives  $H(z)$

### SYSTEMATIC ERRORS

- Galaxy clustering bias
- Redshift space distortion
- Nonlinear gravitational clustering

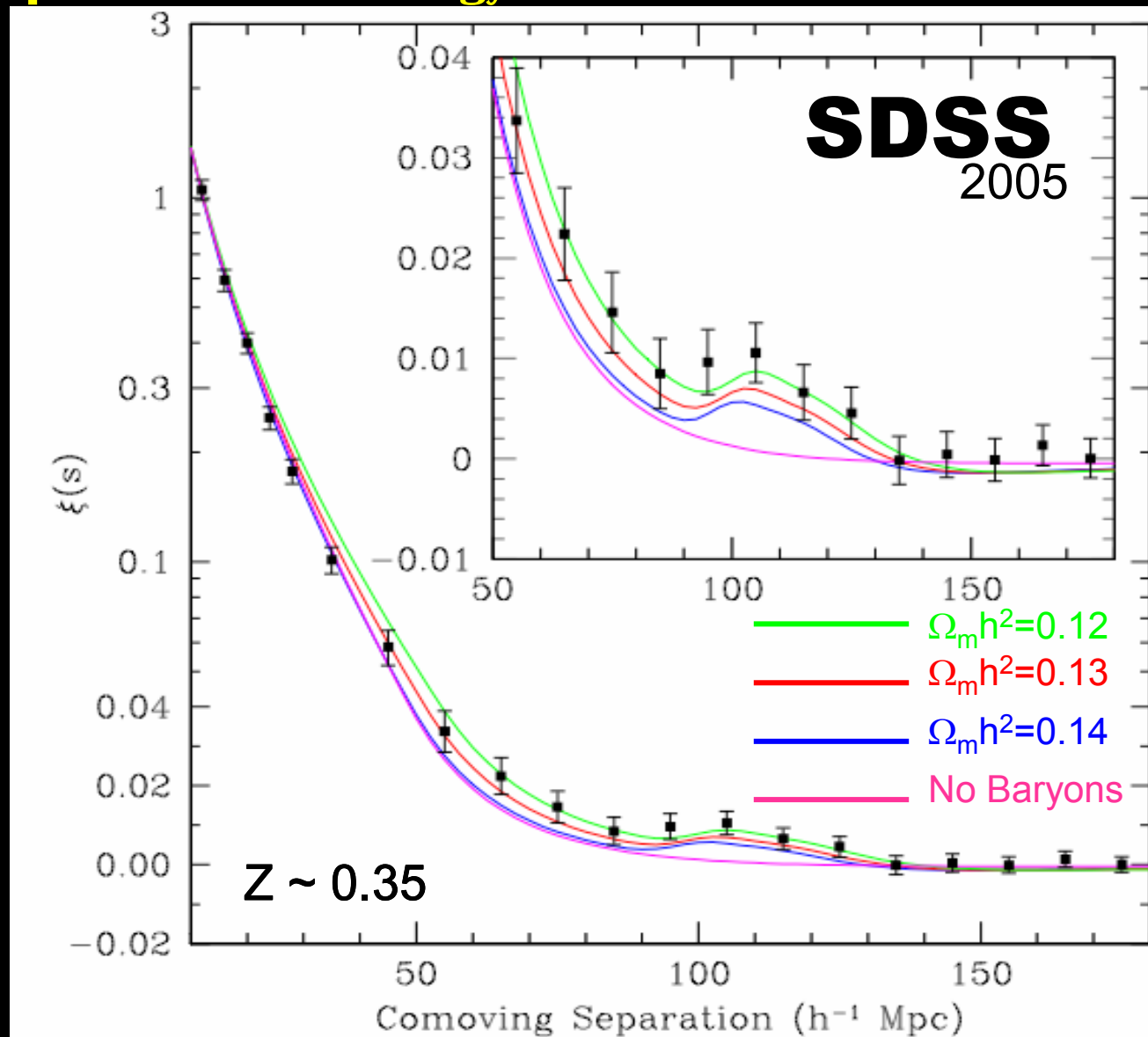

## Number Counts of Clusters of Galaxies

The number of galaxy clusters as a function of angle and redshift is very sensitive to the cosmological parameters, and in particular to the dark energy

Sensitivity comes from the volume element and from the growth of structure as a function of the redshift

$$\frac{dN}{d\Omega dz} = \frac{dV}{d\Omega dz} \times \int_{M_{\min}}^{\infty} dM \frac{dn}{dM}$$

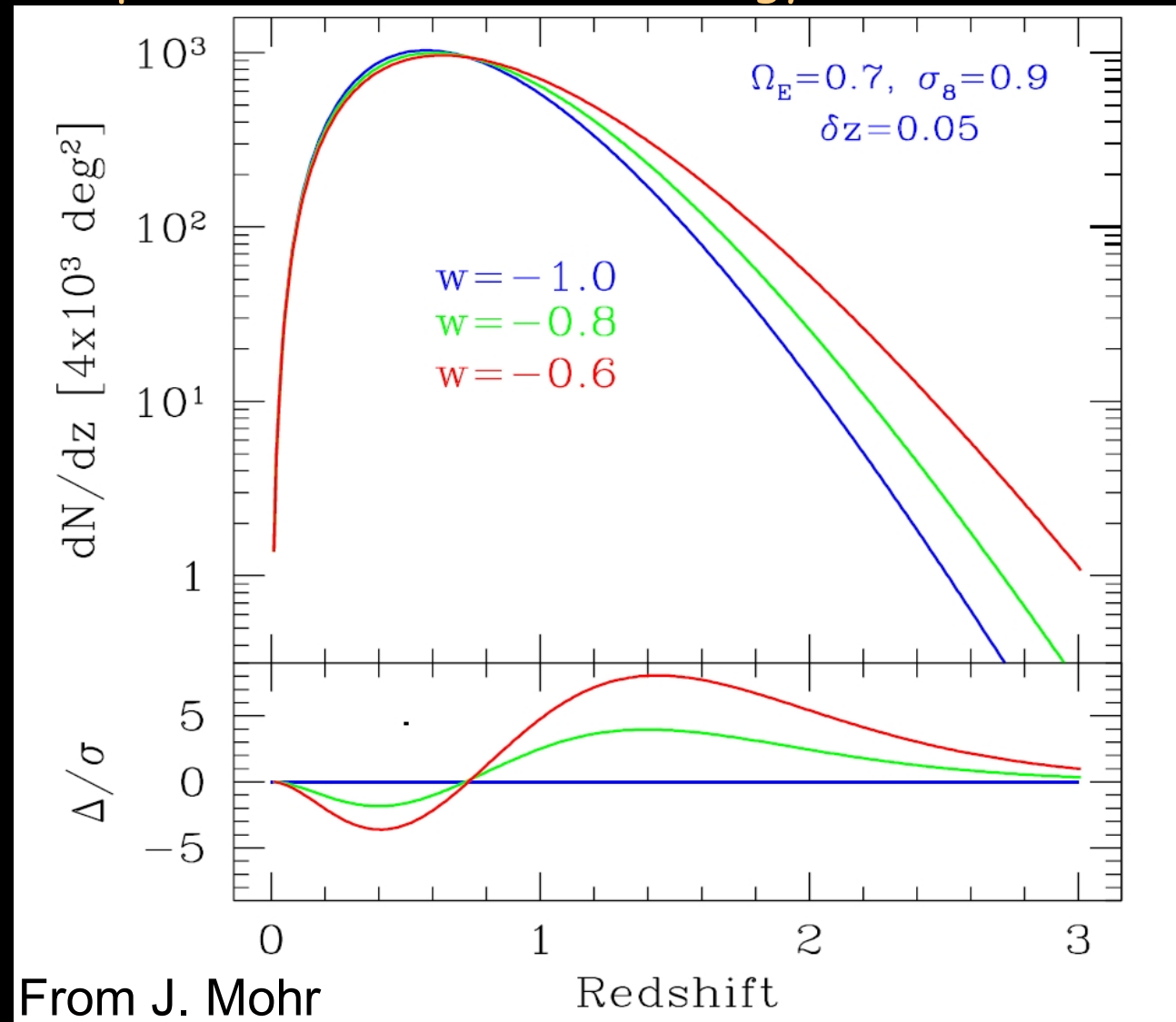

**Jenkins  
et al. 2001**

$$\frac{dn}{dM} = -0.315 \frac{\rho_0}{M} \left( \frac{1}{\sigma_M} \frac{d\sigma_M}{dM} \right) \exp \left\{ - [0.61 - \log(g_z \sigma_M)]^{3.8} \right\}$$

# Number Counts of Clusters of Galaxies

To obtain cosmology from clusters of galaxies, first we have to identify them. Several methods have been proposed:

- **Sunyaev Zel'dovich effect**
- **X-ray emission from cluster gas**
- **Optical data: red sequence richness**
- **Weak lensing (future?)**

Second, we have to measure the cluster mass and redshift

Mass from SZ, X-ray or lensing

Redshift from optical

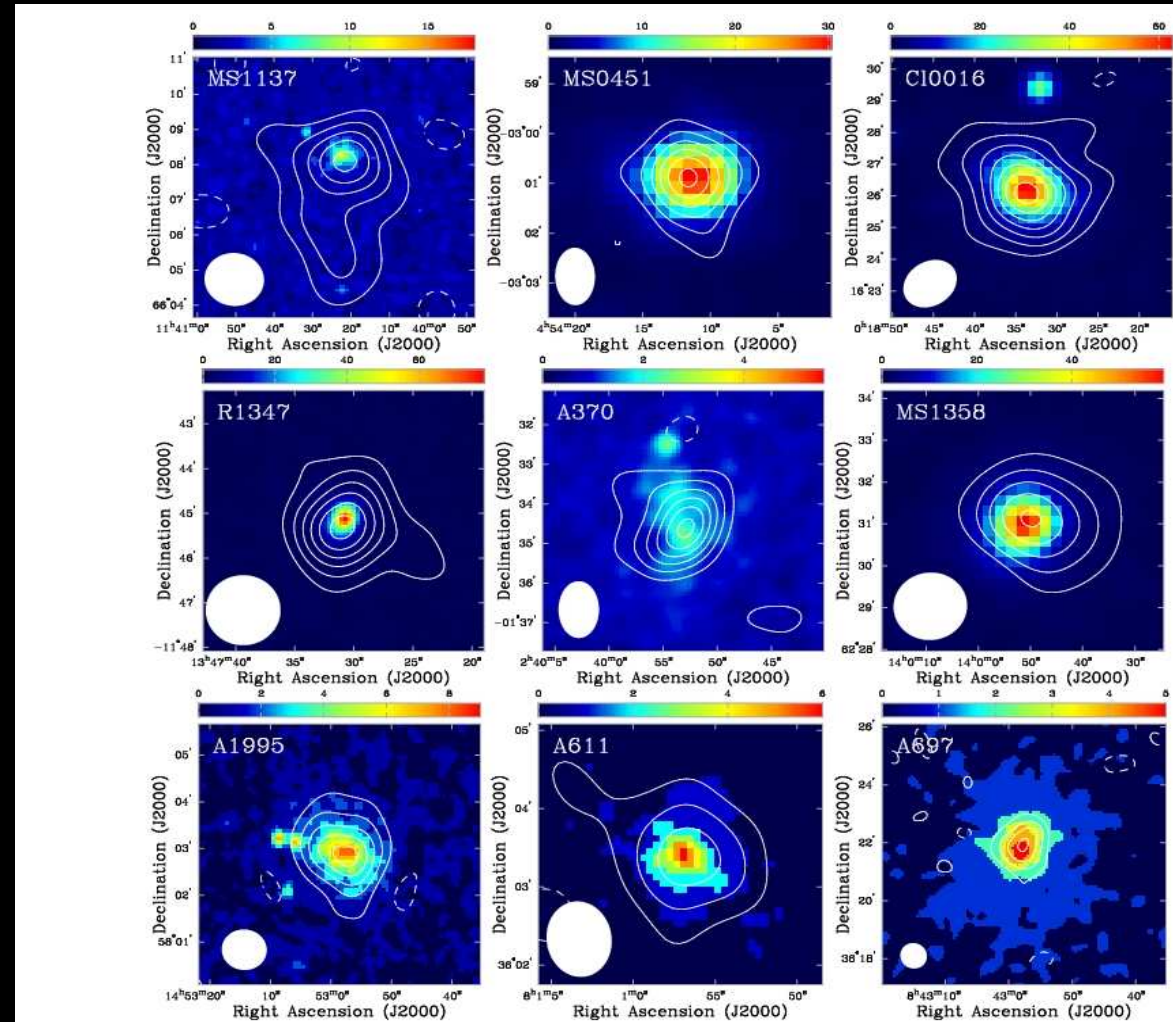

FIG. 2.—SZE (contours) and X-ray (color scale) images of each cluster in our sample. Negative contours are shown as solid lines. The contours are multiples of  $2\sigma$  and the FWHM of the synthesized beams are shown in the bottom left corner. The X-ray color scale images are raw counts images smoothed with Gaussians with  $\sigma = 15''$  for PSPC data and  $\sigma = 5''$  for HRI data. There is a color scale mapping for the counts above each image. The 30 GHz image statistics are summarized in Table 4.

astro-ph/0205350

## Number Counts of Clusters of Galaxies

**This is an emergent and vderly promising method, but not has been probed yet. Its final sensitivity will be fixed by the systematic errors**

### SYSTEMATICS:

Observable-mass relation: X-ray calibration (clusters are not relaxed, additional pressure support), weak lensing calibration (scatter, malmquist bias)

Sample selection

Sources contamination

Photometric redshift

Needs:

**Understanding the formation of dark matter halos**

**Clean way of selecting a large number of clusters**

**Redshift of each cluster**

**Observables that can be used as mass estimators**



# Weak Gravitational Lensing

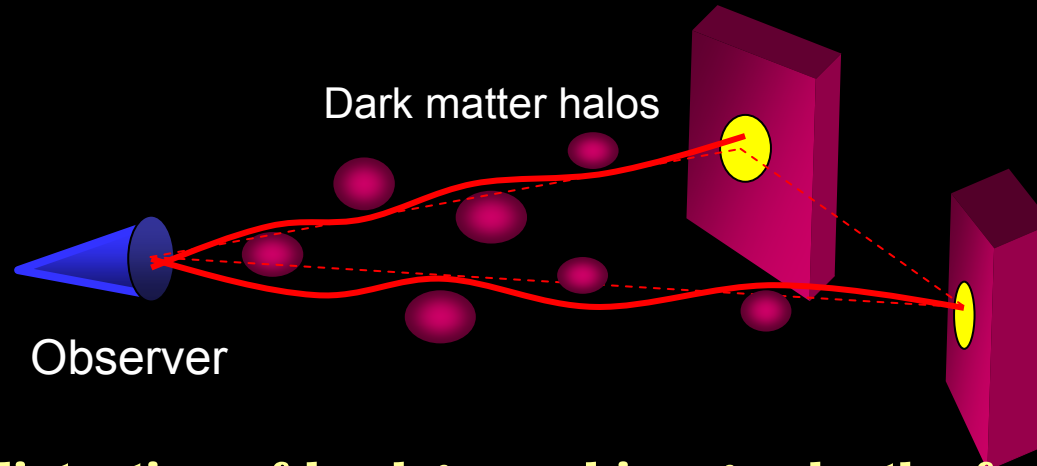

**Measure the distortion of background images by the foreground matter**

**Weak lensing effects of the order of 1%**

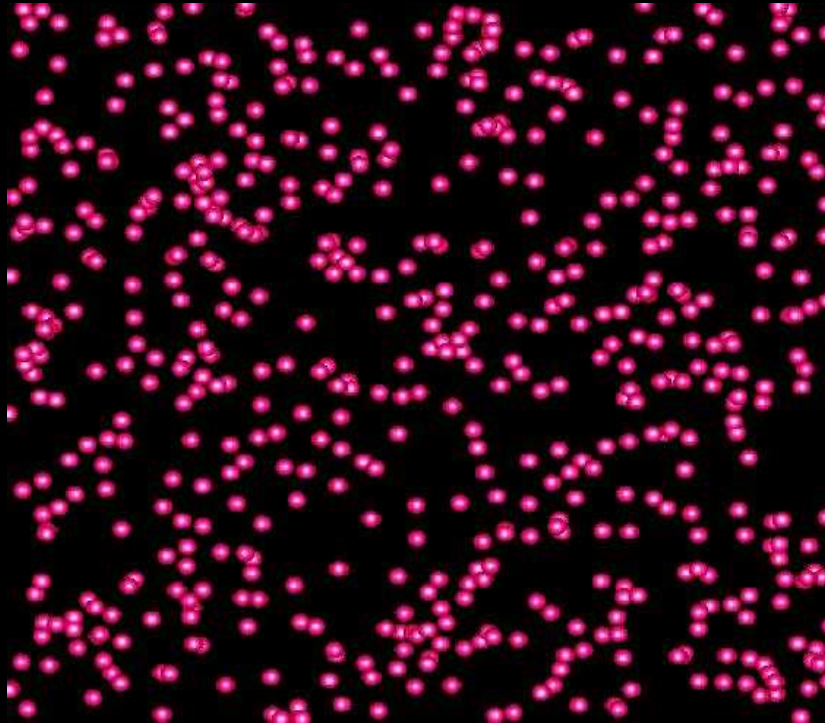

UNLENSED

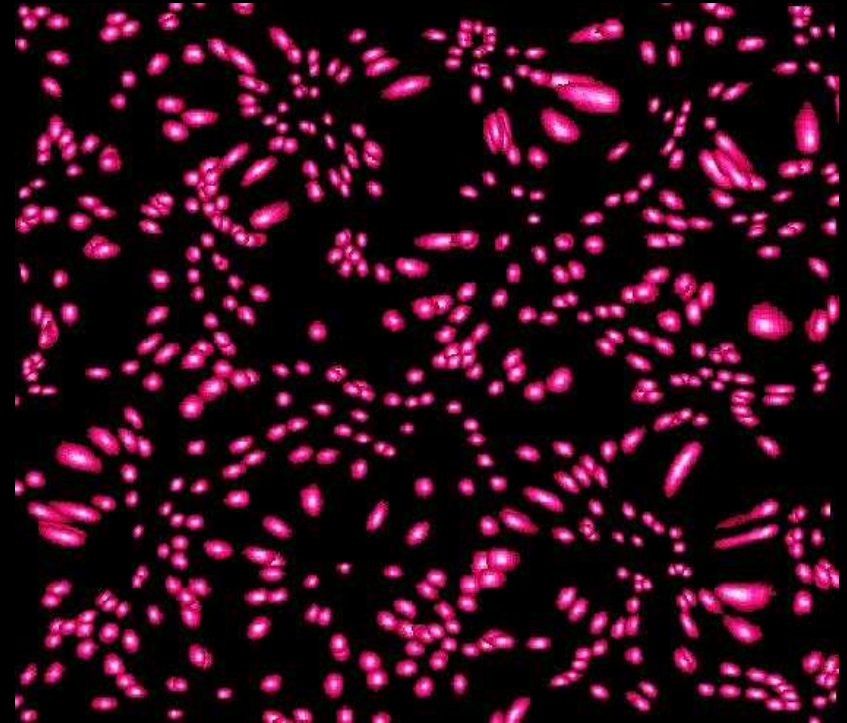

LENSED

## Weak Gravitational Lensing

Magnification and distortion effects due to weak lensing can be used to probe the statistical properties of the matter distribution between the observer and the distant sources.

Assume that galaxies are intrinsically randomly oriented . Then, any coherent alignment of images signals the presence of an intervening tidal gravitational field.

The positions on the sky of galaxies at different distances should be independent. A statistical association of foreground galaxies with background galaxies can indicate the magnification.

**Weak lensing is sensitive to cosmology through distances and the growth factor.**

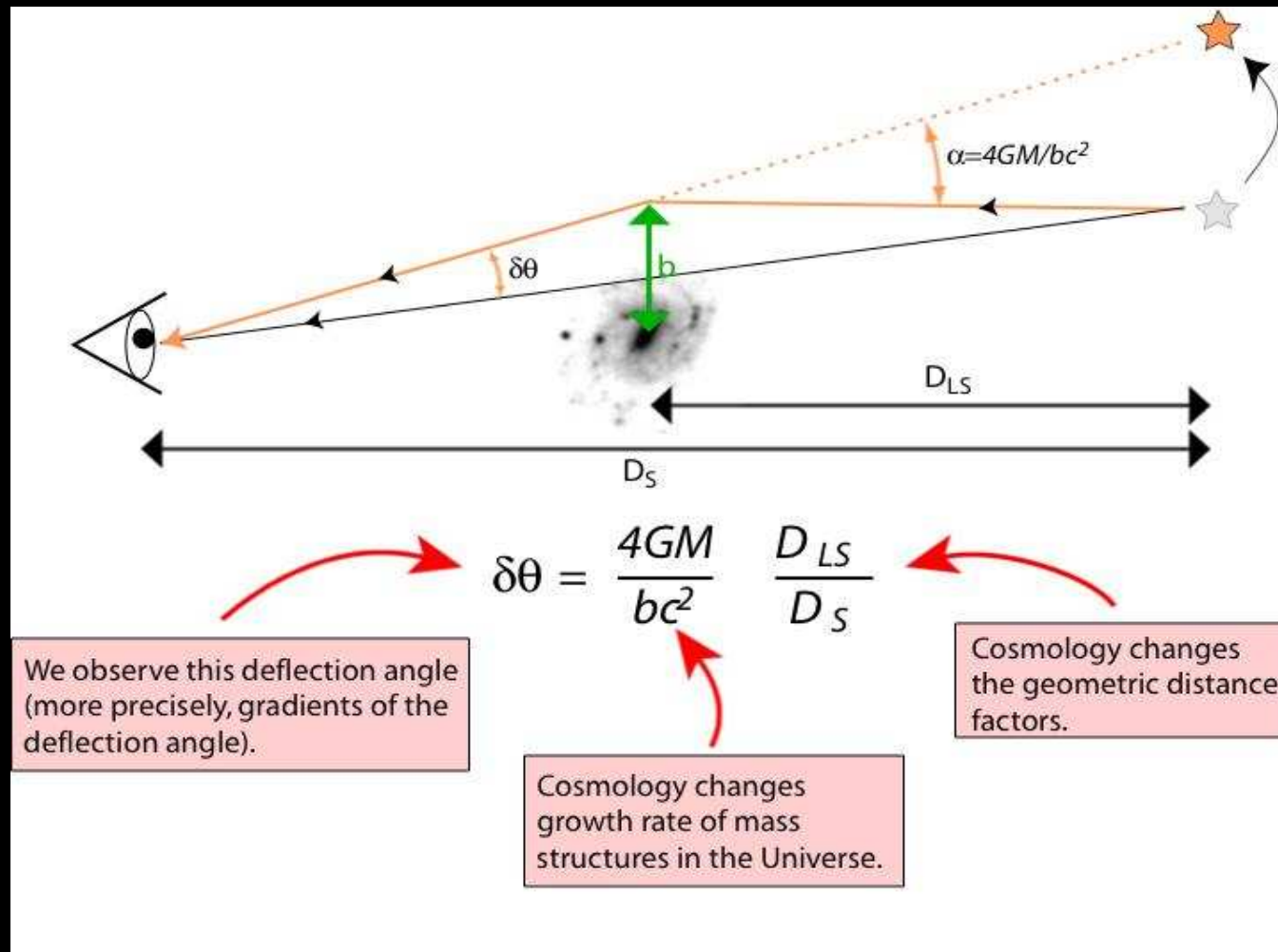

## Weak Gravitational Lensing

**The most powerful technique, but also the most difficult to implement in practice.**

### Systematics:

- Theory: Small scale power spectrum
- Galaxy shape measurement
  - PSF shape leaks into galaxies (additive shear)
  - Incorrect calibration (multiplicative effect)
- Wrong redshift
  - Random errors in photometric redshift
  - Biases in photometric redshift (photometry errors or calculation method)
- Intrinsic alignment
- False detections shear
- Use self calibration
- Control the PSF very carefully.

## Current Situation: June 2007

Taken from T.M.Davis et al., astro-ph/0701510. It includes:

### - SN data

- Near-by from Calan/Tololo and others
- Medium  $z$  from SNLS (Astier et al. 2006) and ESSENCE (Wood-Vasey et al. 2007)
- High  $z$  from HST (Riess et al. 2006)
- No systematic errors considered (?)
- Determine  $H_0 d_L(z)$  (independent of  $h$ ) for  $0.1 < z < 1.7$  to 3-15%.

### - BAO data from SDSS (Eisenstein et al. 2005)

- Determine  $\left[ d_A^2(z) \frac{z}{H(z)} \right]^{1/3} \frac{\sqrt{\Omega_m H_0^2}}{z}$  (independent of  $h$ ) at  $z = 0.35$  to 3.6%.

### - CMB data from WMAP 3 years (Spergel et al. 2006)

- Determine  $d_A(z) \sqrt{\Omega_m H_0^2}$  (independent of  $h$ ) at  $z = 1089$  to 1.8%.

### - No clusters

### - No weak lensing

## Current Situation: June 2007

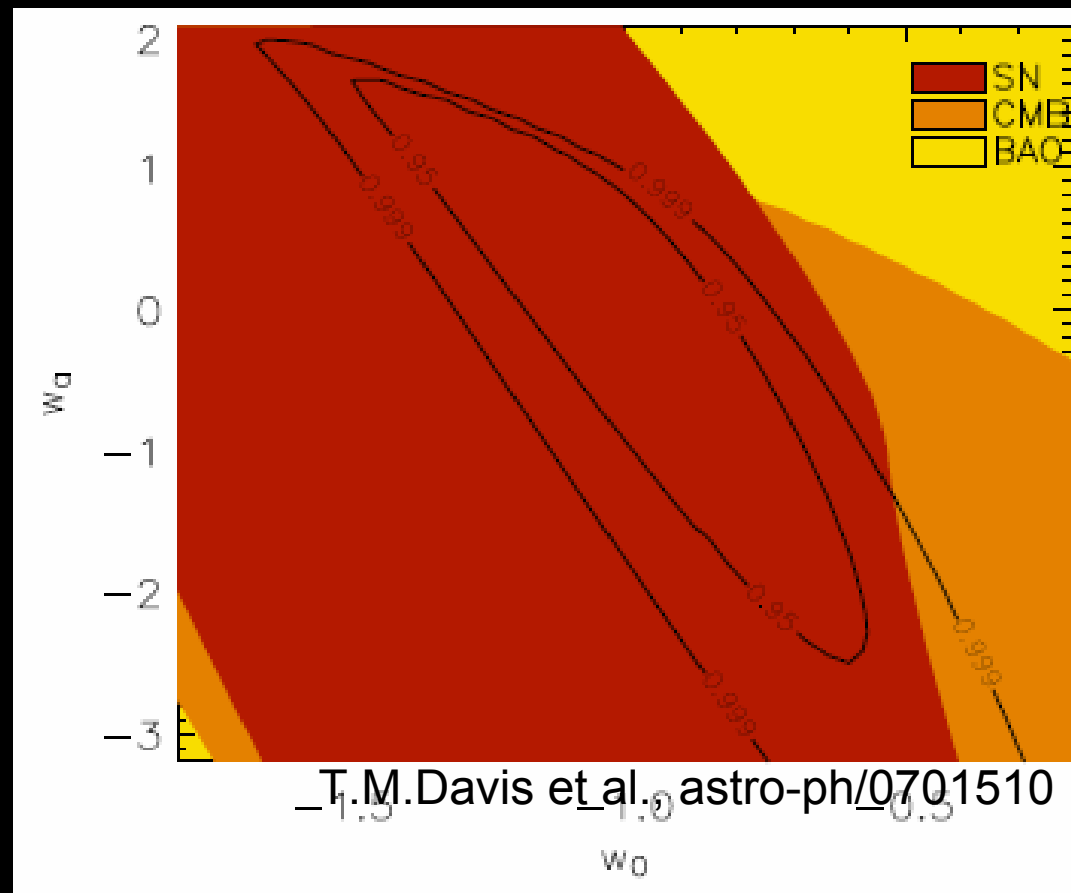
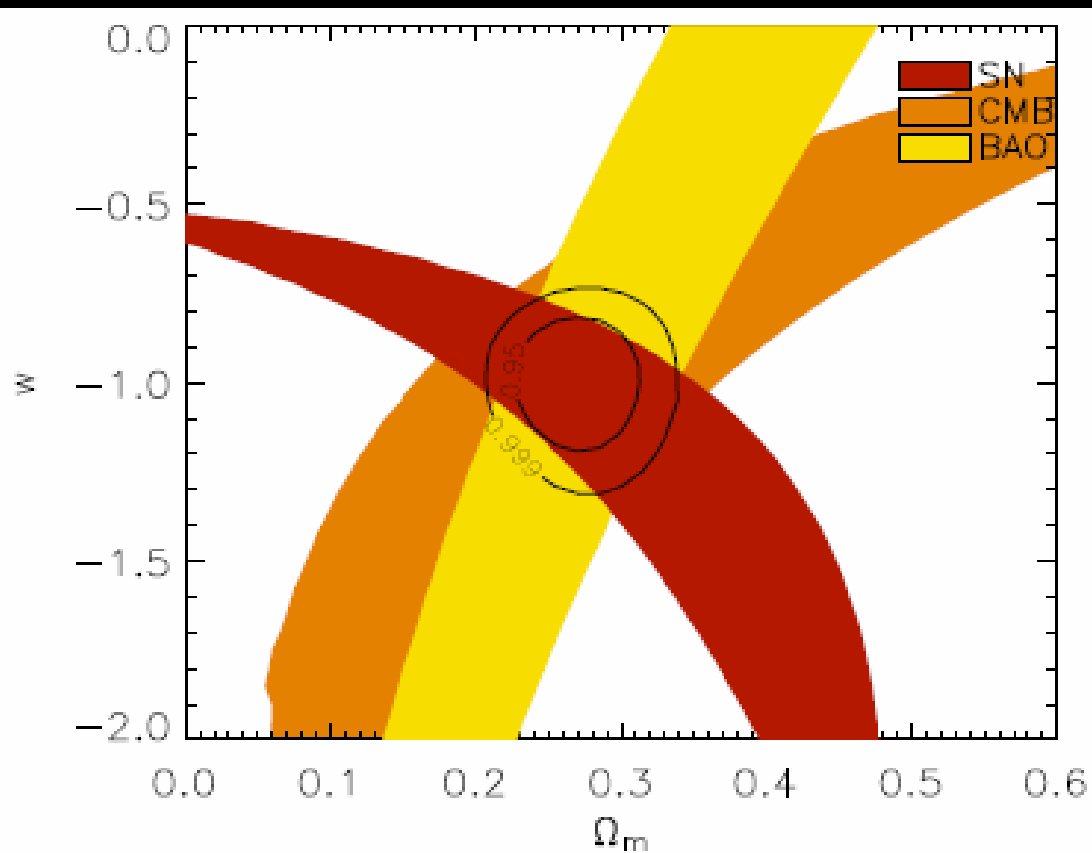

- Some constraint in  $w$ - $\Omega_M$  plane
- Almost no sensitivity in  $w_0$ - $w_a$  plane
- FoM  $\sim 1$



## Current Situation: Supernovae

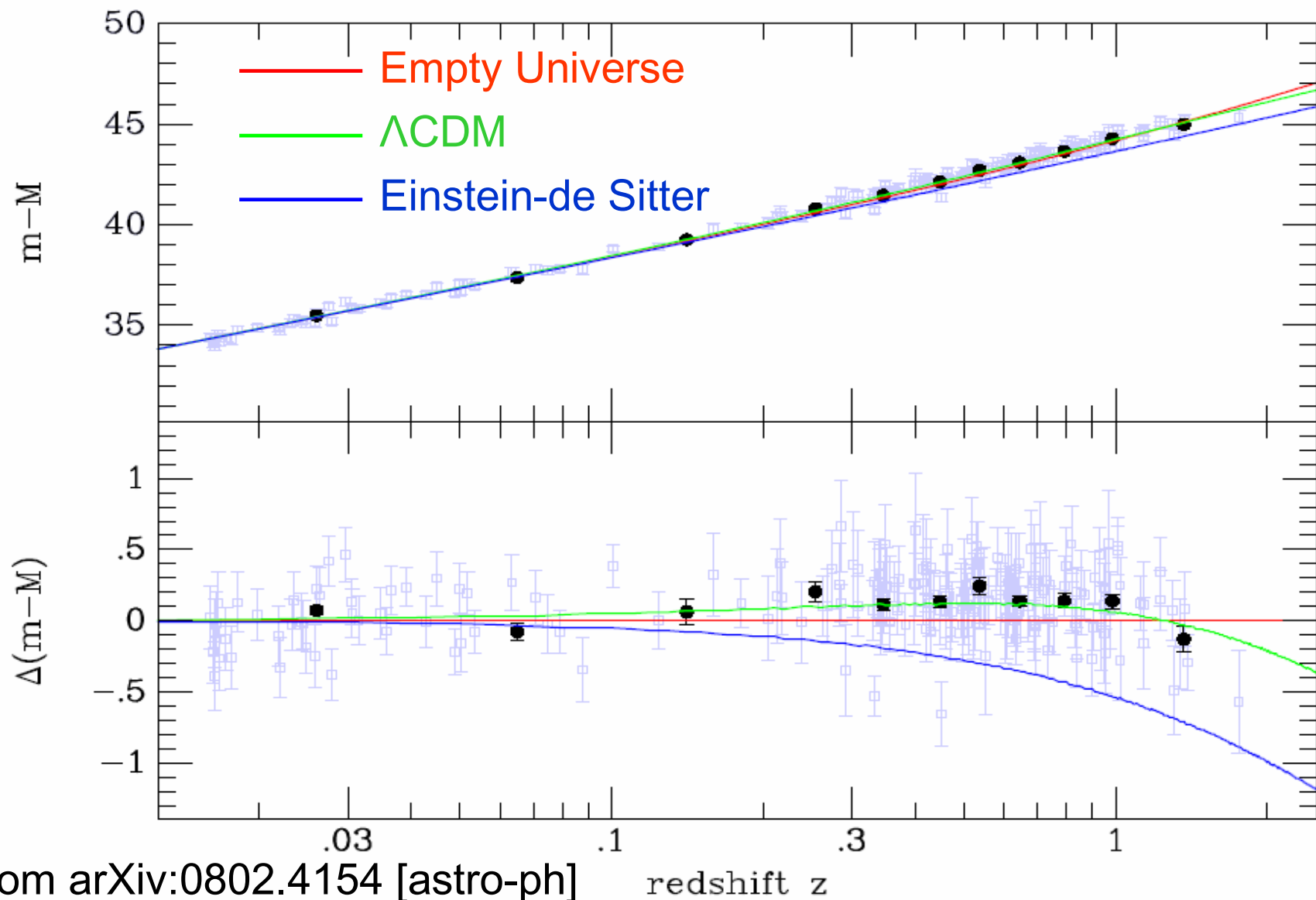

$\Lambda$ CDM describes the supernovae data. It is important to notice that both the recent acceleration epoch and the previous deceleration epoch are seen. The transition is around  $z \sim 0.8$

## Current Situation: CMB

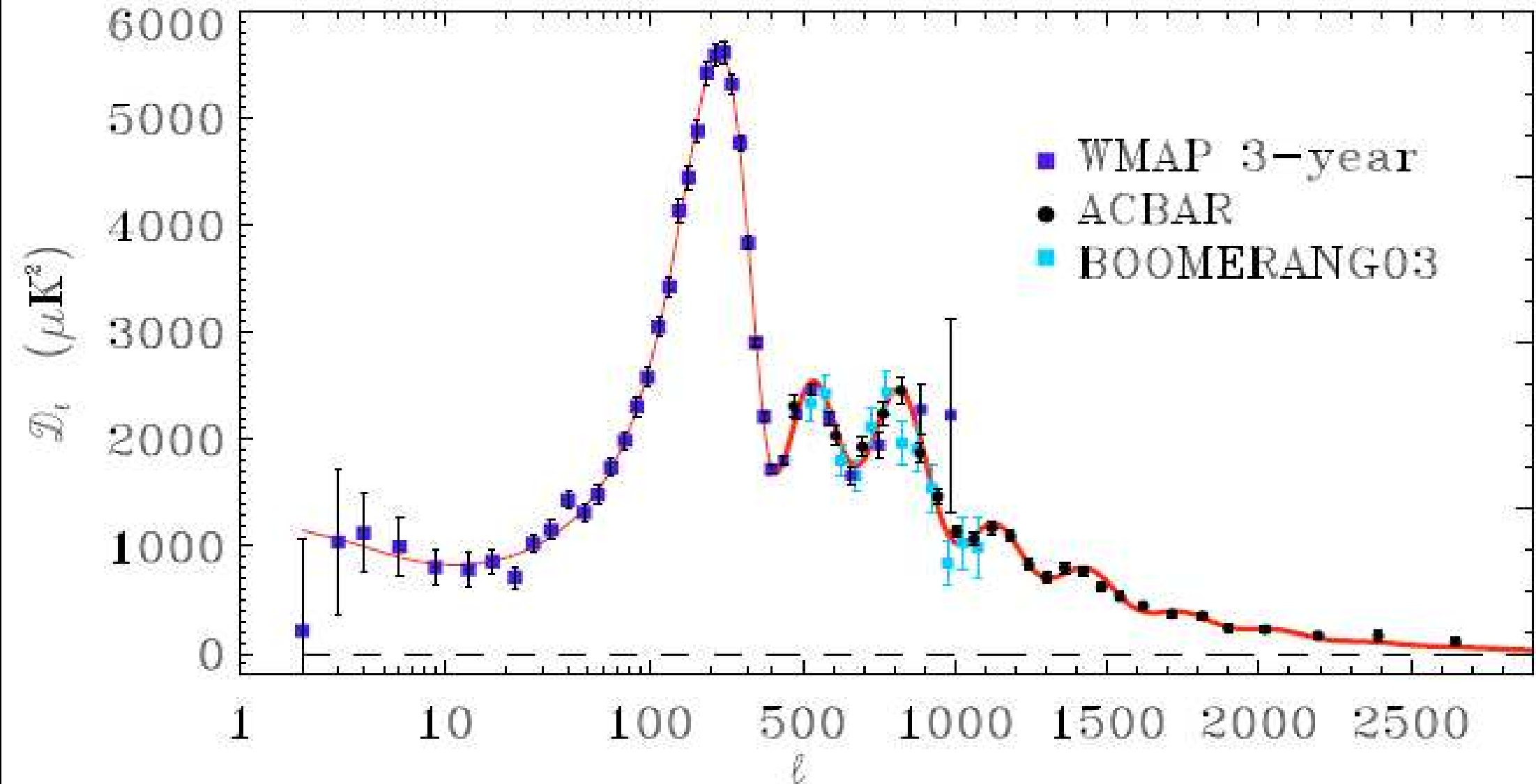

**WMAP3+ACBAR: 5 peaks of the power spectrum already detected**

**New expected results mostly from SNe and CMB:**

**- SN data**

- SN Factory should add about 300 near-by SNe
- Full SNLS and ESSENCE data sample: about 500 medium-z SNe.
- SDSS-II/SNe sample of about 300 SNe with  $0.1 < z < 0.3$
- Systematic errors guessed as 0.02 mag in each bin with  $\Delta z = 0.1$ .
- Determine  $H_0 d_L(z)$  (independent of  $h$ ) for  $0.1 < z < 1.7$  to 2-15%.

**- BAO data from SDSS (Eisenstein et al. 2005)**

- Determine  $\left[ d_A^2(z) \frac{z}{H(z)} \right]^{1/3} \frac{\sqrt{\Omega_m H_0^2}}{z}$  (independent of  $h$ ) at  $z = 0.35$  to 3.6%.

**- CMB data from Planck (probably slightly later than 2010)**

- Determine  $d_A(z) \sqrt{\Omega_m H_0^2}$  (independent of  $h$ ) at  $z = 1089$  to 0.7%.

**- No clusters**

**- No weak lensing**

## DETF Projections

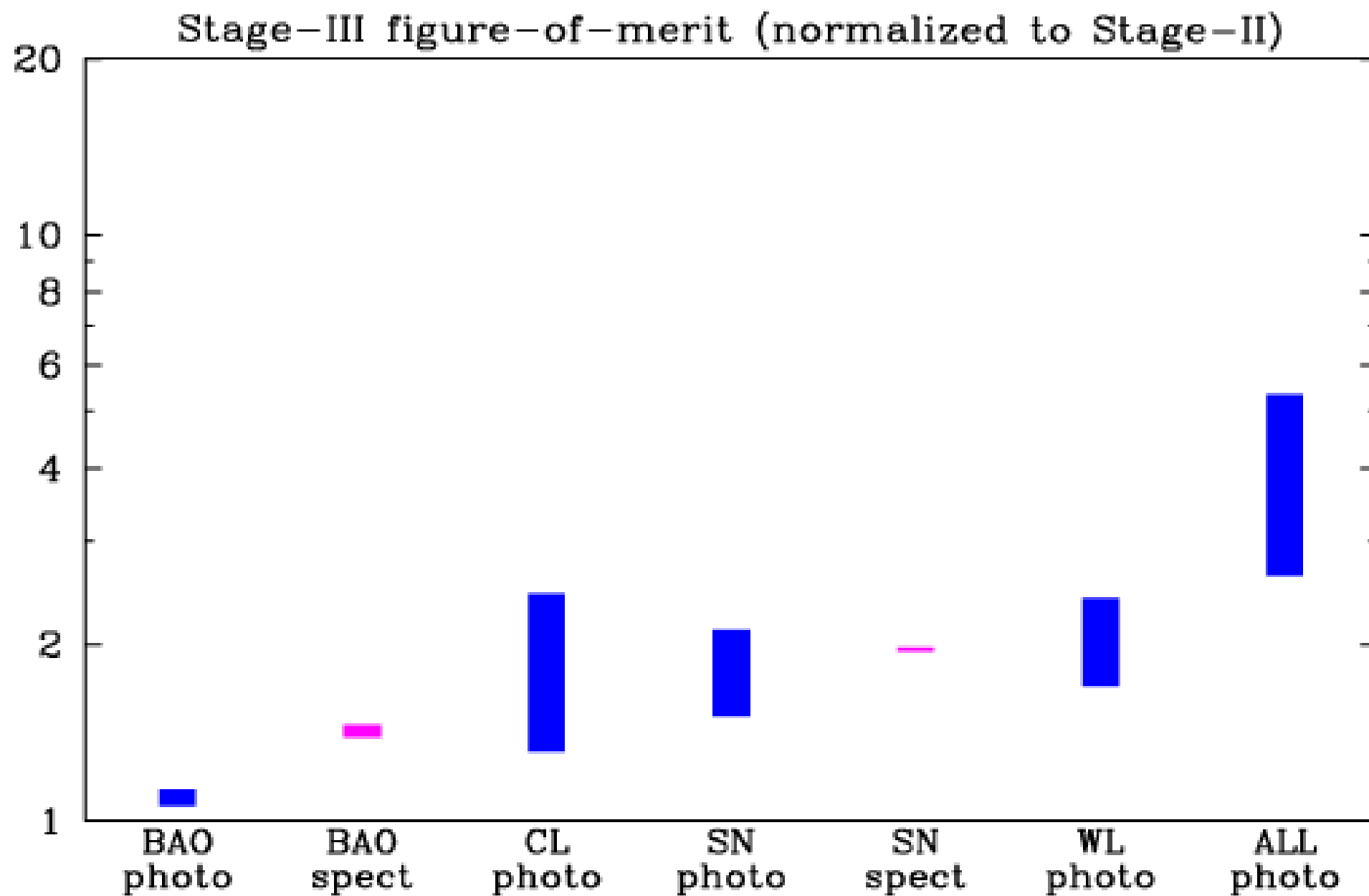

### **Many new surveys in all four techniques:**

- **DES** : 5000 deg<sup>2</sup> in *grizY* (plus VISTA's *JHK*) to  $i = 24$  ( $z < 1.3$ )
  - BAO with photo-z with 300 M galaxies.
  - WL with photo-z with 300 M galaxies.
  - Cluster photo-z for  $O(10,000)$  SPT clusters.
  - $O(1000)$  SNe with  $z < 1$
- **PanSTARRS-1**
  - Can do a program similar to DES (except for clusters, probably), but it's not so well defined at this point
- **Many BAO spectroscopic projects**
  - BOSS, Wiggle-Z, WFMOS, HETDEX
- **Will not cover LSST, PanSTARRS-4**
  - Most probably on a longer time scale
- **Will not cover space missions (ADEPT, DUNE, SNAP, SPACE)**
  - Surely on a longer time scale

## BAO spectroscopic surveys by 2015

<b>Survey</b>	<b>Redshift</b>	<b>Sky area (deg<sup>2</sup>)</b>	<b>Million Galaxies</b>	<b>Vol. (Gpc<sup>3</sup>)</b>	<b>Funded(F) or Proposed(P)</b>
<b>PAU-BAO</b>	<b>0.1&lt;z&lt;1</b>	<b>8000 (4 yr)</b>	<b>43</b>	<b>24</b>	<b>P(2010 - 14)</b>
<b>Wiggle-Z AAT</b>	<b>0.5&lt;z&lt;1.0</b>	<b>1000</b>	<b>0.4</b>	<b>2.9</b>	<b>P</b>
<b>APO-LSS SDSS- III (BOSS)</b>	<b>0.2&lt;z&lt;0.8</b>	<b>10000</b>	<b>1.5</b>	<b>21</b>	<b>P(2009 - 13) Spectra</b>
<b>WF MOS Subaru</b>	<b>0.5&lt;z&lt;1.3</b>	<b>2000</b>	<b>2</b>	<b>12</b>	<b>P</b>
<b>WF MOS++ Subaru</b>	<b>2.3&lt;z&lt;3.3</b>	<b>300</b>	<b>0.6</b>	<b>3.5</b>	<b>P</b>
<b>SDSSII 8Yr LRG</b>	<b>0.16&lt;z&lt;0.47</b>	<b>7600</b>	<b>0.094</b>	<b>4.4</b>	<b>F, running</b>
<b>HETDEX</b>	<b>1.8&lt;z&lt;3.8</b>	<b>200</b>	<b>1</b>	<b>4.7</b>	<b>P</b>
<b>SDSS LRG</b>	<b>0.16&lt;z&lt;0.47</b>	<b>3800</b>	<b>0.047</b>	<b>2.2</b>	<b>Complete</b>
<b>SDSS main 2dF</b>	<b>z&lt;0.3</b>	<b>7000</b>	<b>0.7</b>	<b>1.2</b>	<b>Complete</b>



## Imaging surveys

<b>Survey</b>	<b>Depth</b>	<b>Sky area (deg<sup>2</sup>)</b>	<b>Filters</b>	<b>Status</b>
<b>Subaru</b>	<b>Deep</b>	<b>30</b>	<b>1</b>	<b>Observing</b>
<b>CFH Legacy</b>	<b>Moderate</b>	<b>170</b>	<b>5</b>	<b>Observing</b>
<b>RCS2 (CFH)</b>	<b>Shallow</b>	<b>830</b>	<b>3</b>	<b>Approved</b>
<b>VST/KIDS/VISTA</b>	<b>Moderate</b>	<b>1700</b>	<b>4+5</b>	<b>50% approved</b>
<b>DES</b>	<b>Moderate</b>	<b>5000</b>	<b>4</b>	<b>Proposed</b>
<b>Pan-Starrs</b>	<b>Moderate</b>	<b>~10000?</b>	<b>5?</b>	<b>Proposed</b>
<b>LSST</b>	<b>Deep</b>	<b>20000</b>	<b>5</b>	<b>Proposed</b>
<b>JDEM</b>	<b>Deep</b>	<b>1000+</b>	<b>9</b>	<b>Proposed</b>
<b>VST/VISTA</b>	<b>Moderate</b>	<b>5000?</b>	<b>4+5</b>	<b>Proposed</b>
<b>DUNE</b>	<b>Moderate</b>	<b>20000</b>	<b>2+1?</b>	<b>Proposed</b>

## Comparison of survey powers

Etendue = Area x Solid Angle

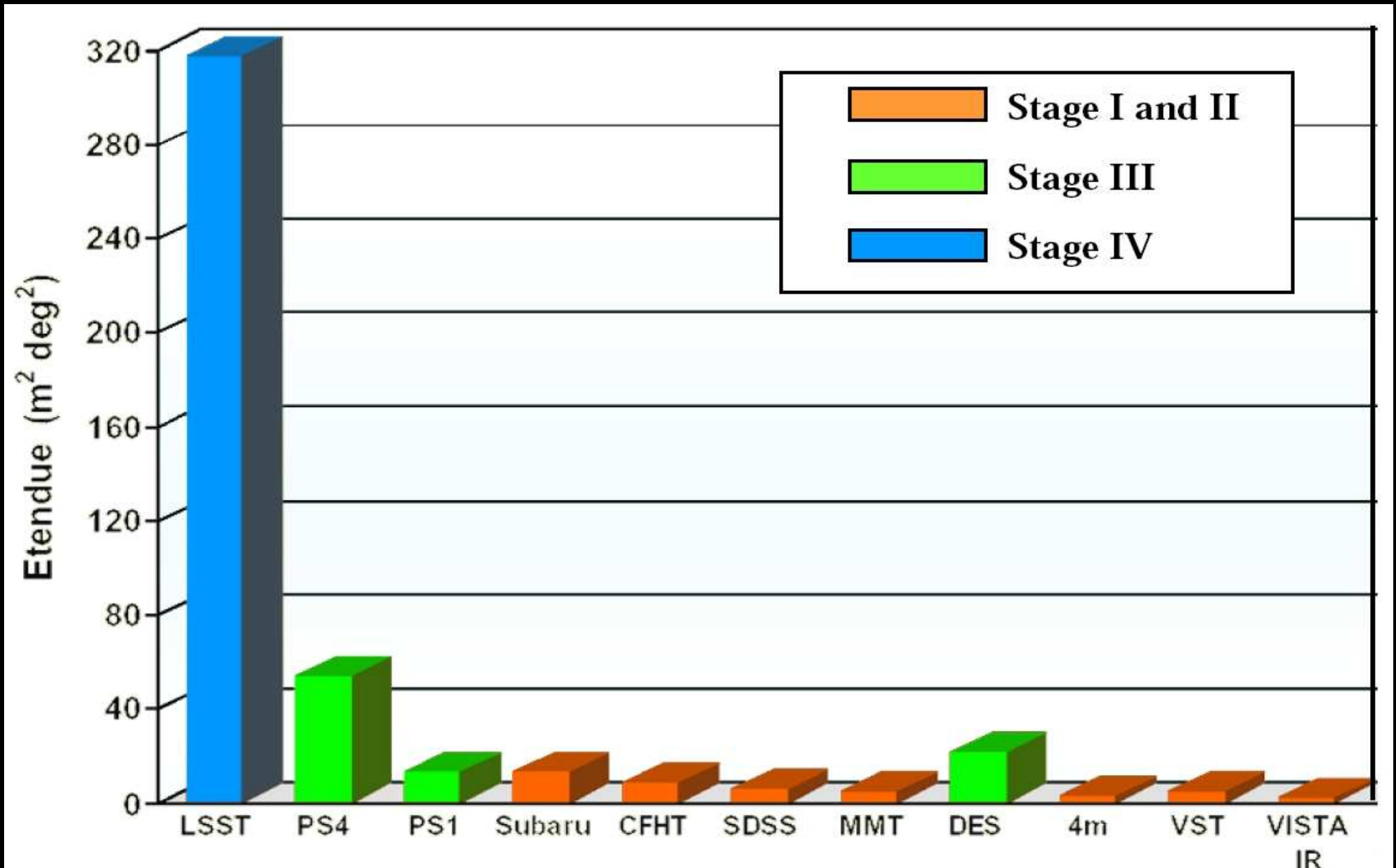

# Expectations of DETF for Stage IV

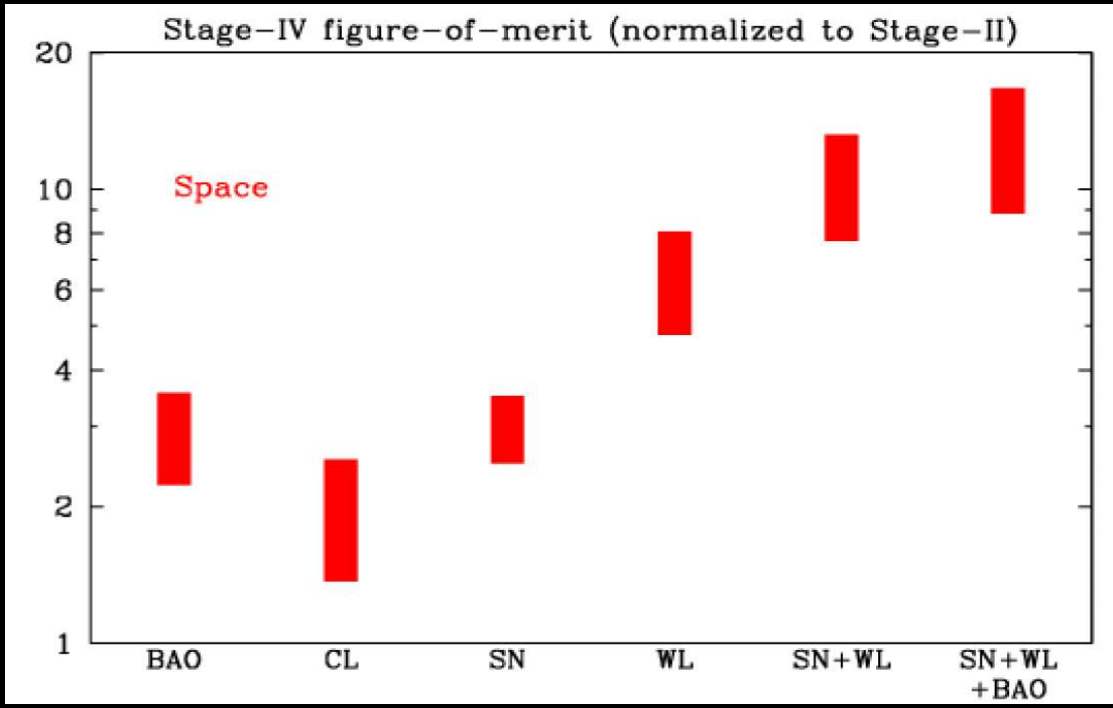
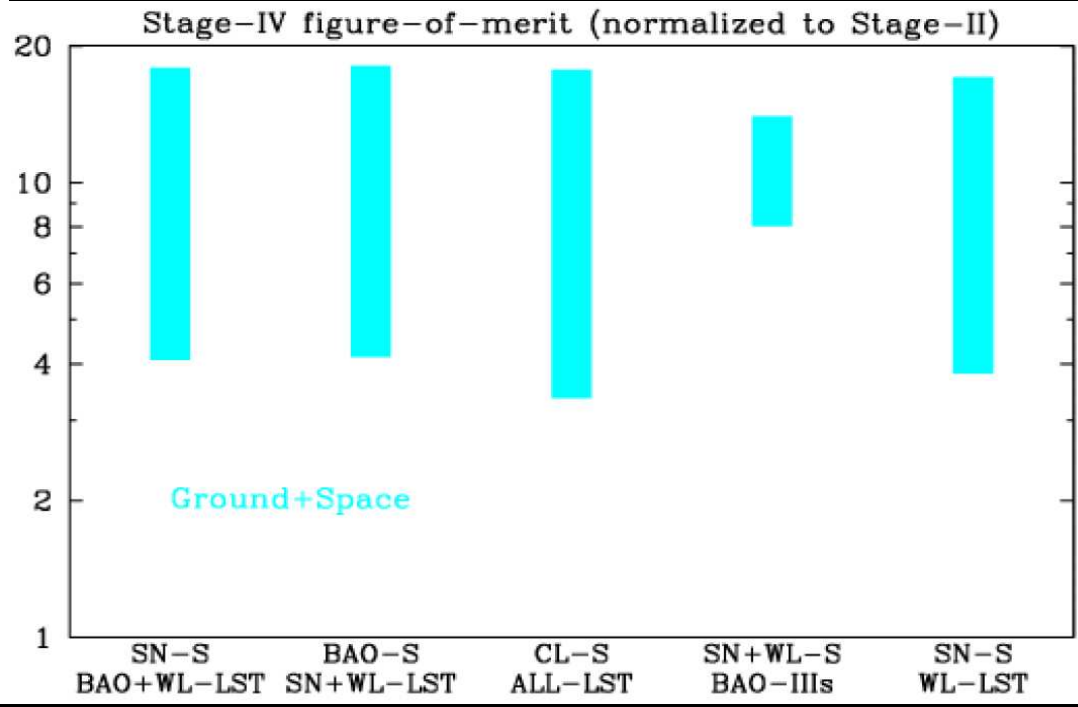
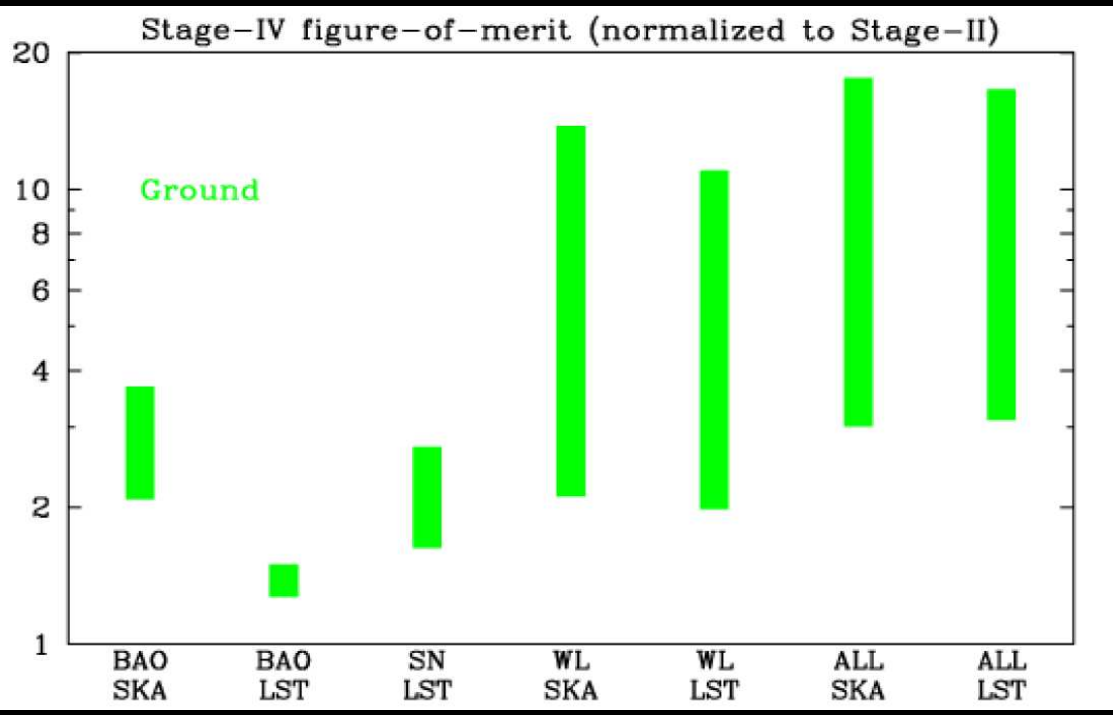



DARK ENERGY  
SURVEY

# The Dark Energy Survey: The Instrument

Survey 5000 sq-degrees in  
the South Galactic Cap  
30% DES, 70% of public use

Use 4m Blanco Telescope at  
CTIO (Chile); and existing  
and working telescope

DES will replace the entire  
cage at the prime focus

Install a new camera and  
new optics

SDSS g,r,i,z filters covering  
visible and infrared (correlate  
with Vista VHS to go further  
in IR)

Each image will cover 3 sq-  
degrees (~20 clusters and  
~20000 galaxies)

~300 GB image data/night





# The Dark Energy Survey: The Instrument



DARK ENERGY  
SURVEY

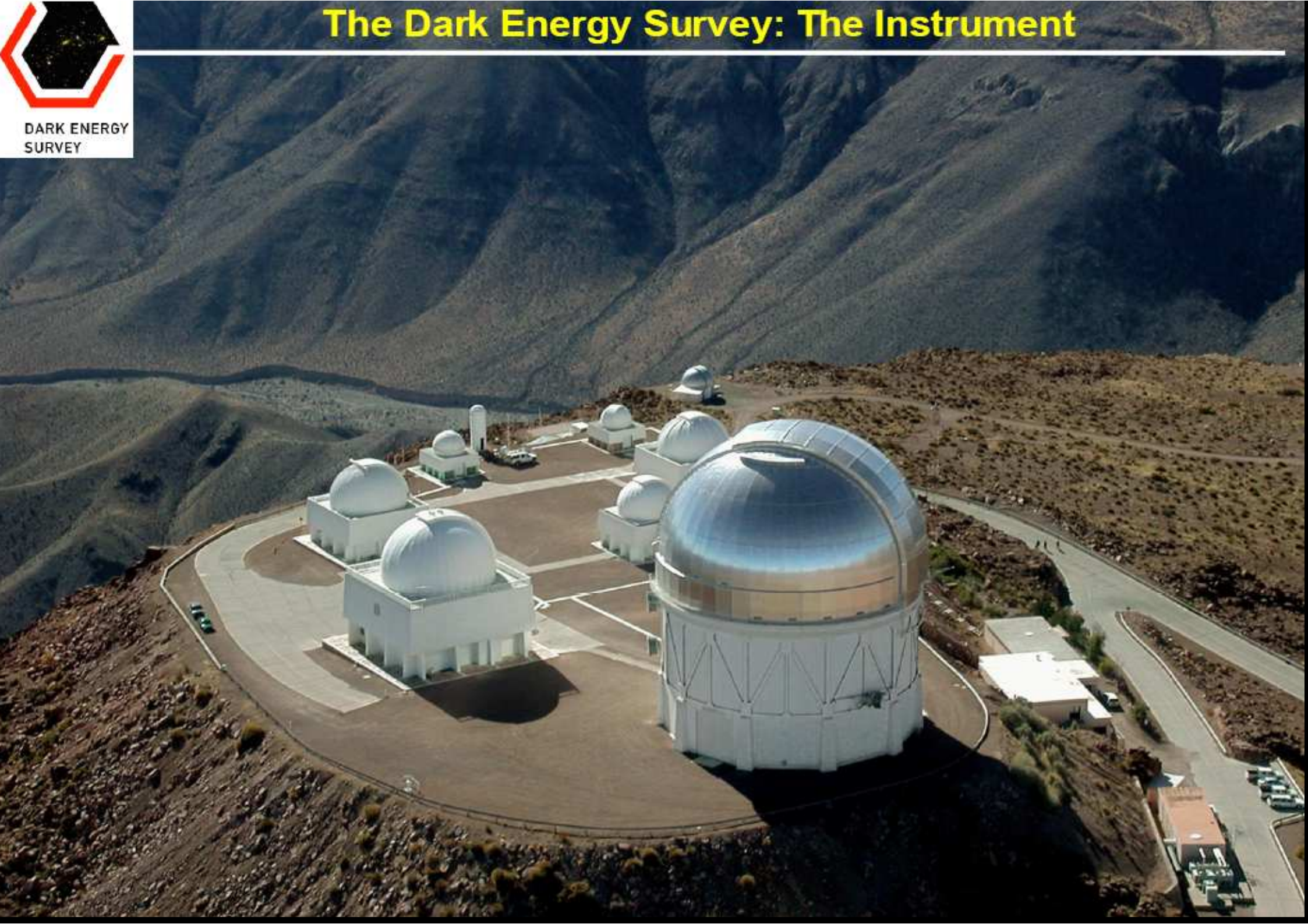





# The Dark Energy Survey: The Camera

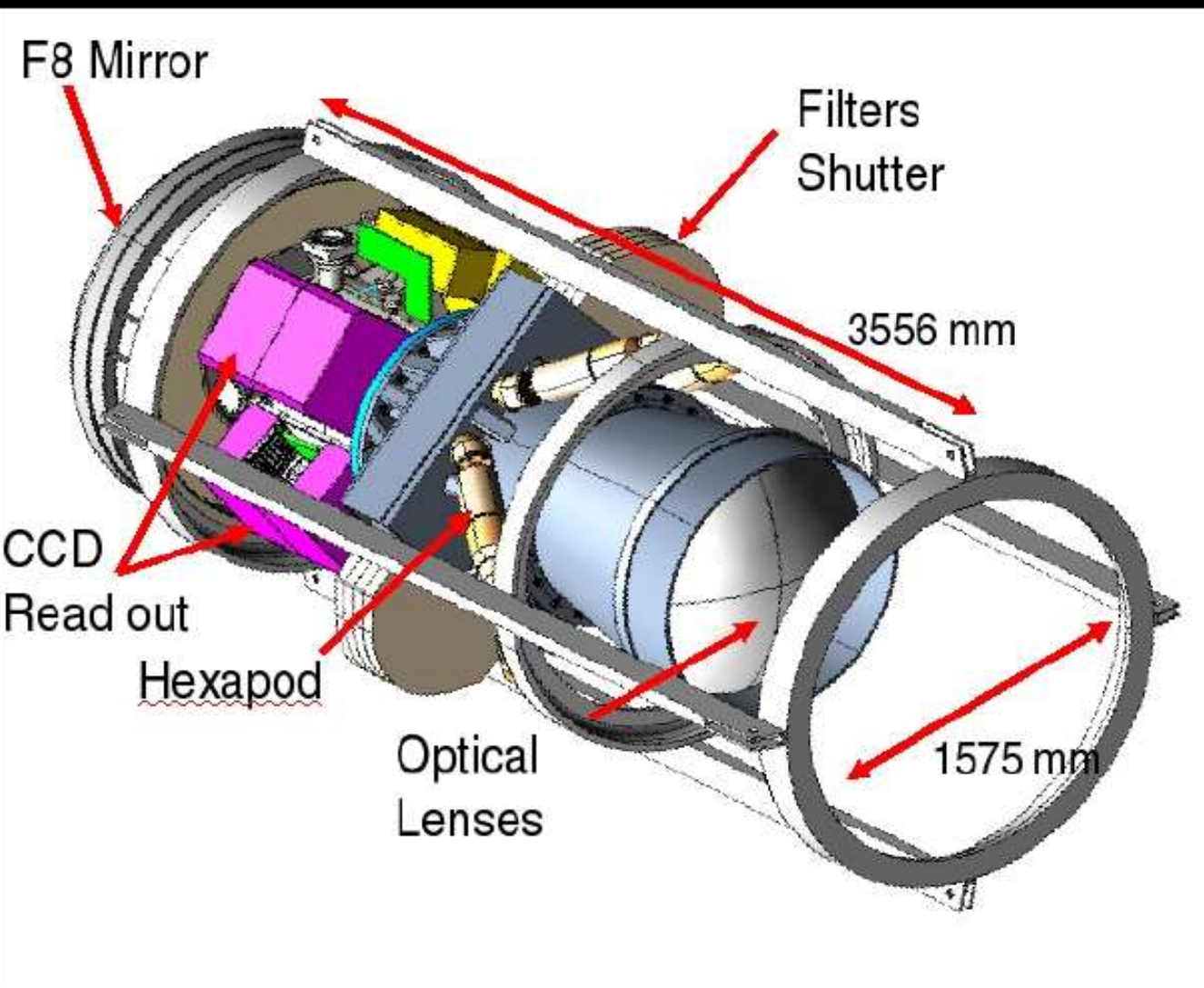

*DES is building a new camera for Blanco: DECam*

*500 million pixels*

*Sensitive to visible and near IR*

*DES is building also the associated optics*

*DECam will be installed at the prime focus of the telescope*

*It is a mobile piece. It can be rotated to use a mirror at the back*



# The Dark Energy Survey: The Camera

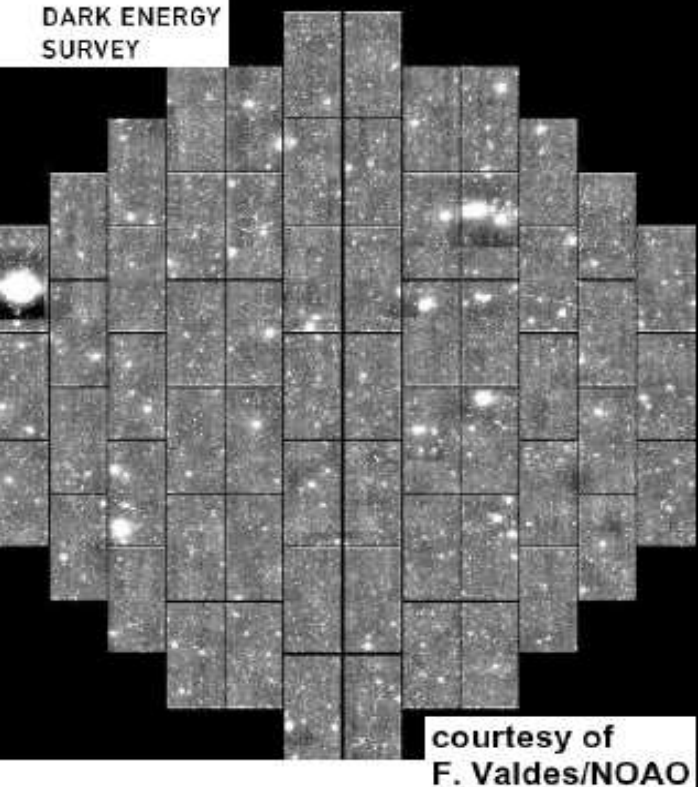

courtesy of  
F. Valdes/NOAO

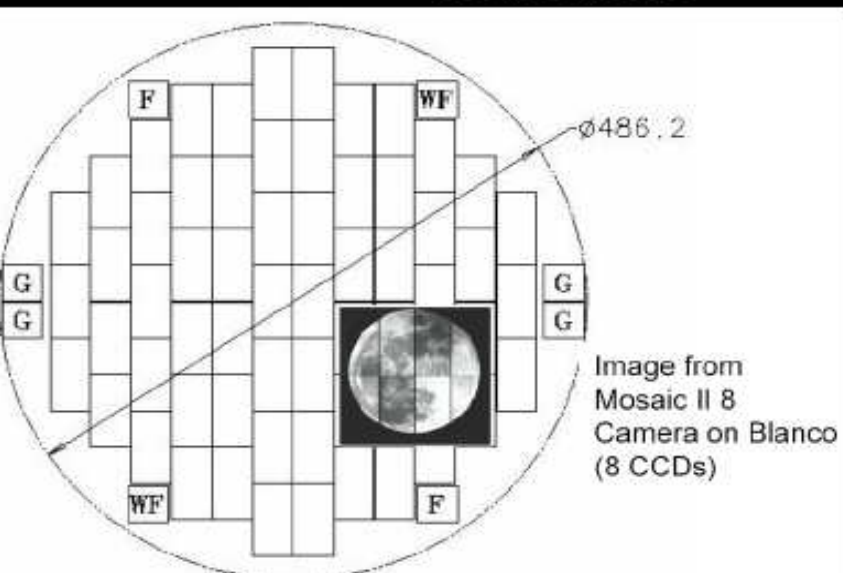

62 2k x 4k image CCDs + 8  
guide and focus CCDs

0.27"/pixel

Scroll shutter: < 3 sec open-  
close

4 filters (g, r, i, z) < 10 sec  
exchange

5 elements optical corrector

Approximately hexagonal



DARK ENERGY SURVEY

# The Dark Energy Survey: CCDs

**Pixel size: 15x15 microns**

**Readout time: 17 sec.**

**Noise: 5e at 250 kpix/sec**

**Quantum Efficiency > 50% at 1000 nm**

**250 microns thick**

**2 Readout channels device**

**Developed by LBNL for SNAP**

**These CCDs have already been used on telescopes in small numbers**

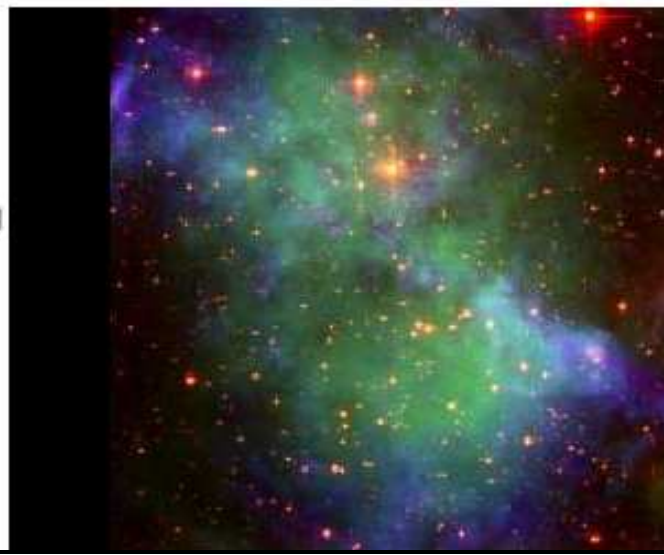
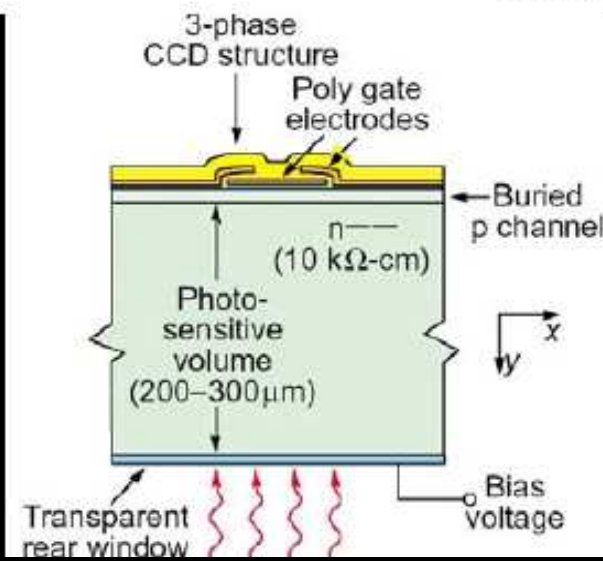
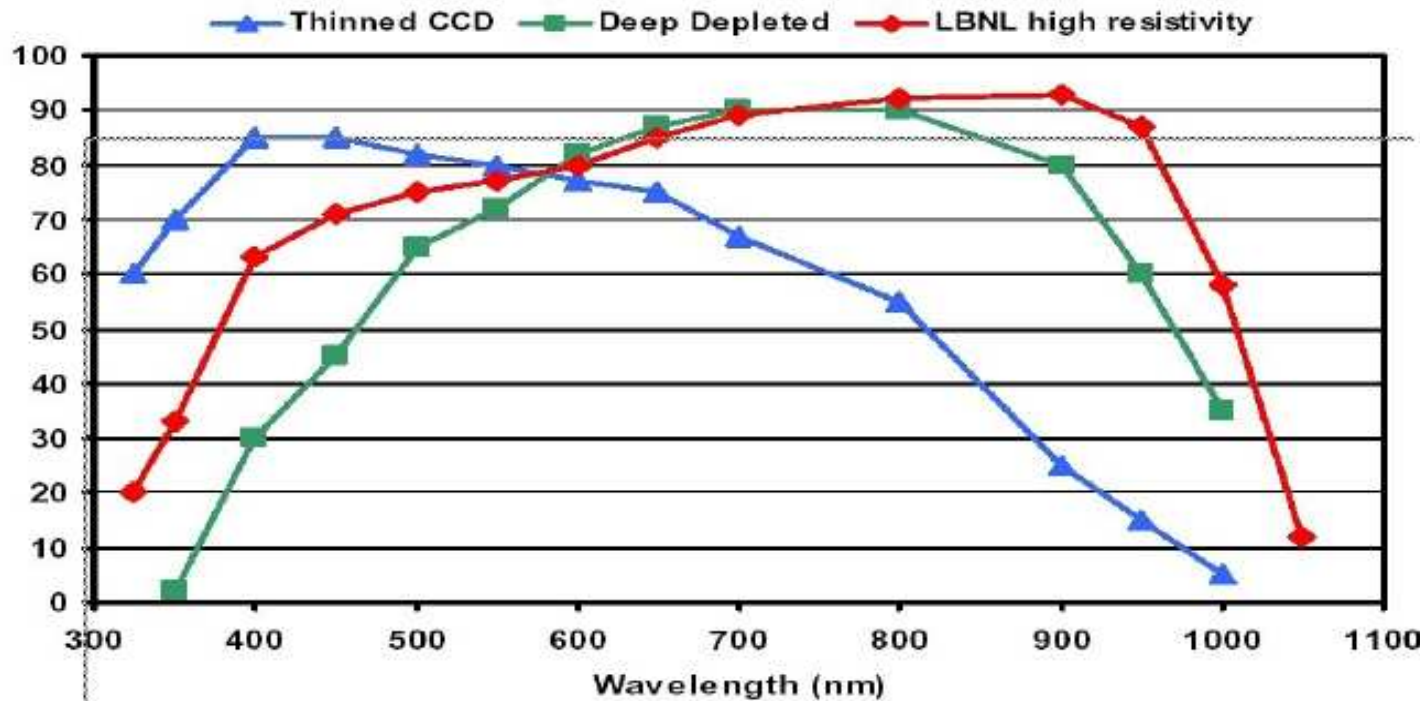





DARK ENERGY SURVEY

# The Dark Energy Survey: Photo-z and data management

## 4 SDSS filters: **g, r, i, z**. From $\sim 3500$ to $\sim 10500$ A

### Target red galaxy spectra at $z=0, 0.5, 1$

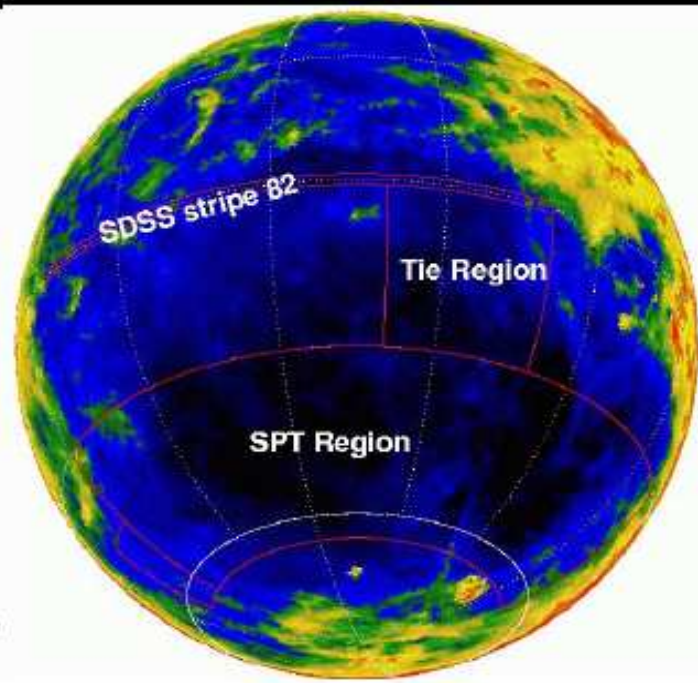
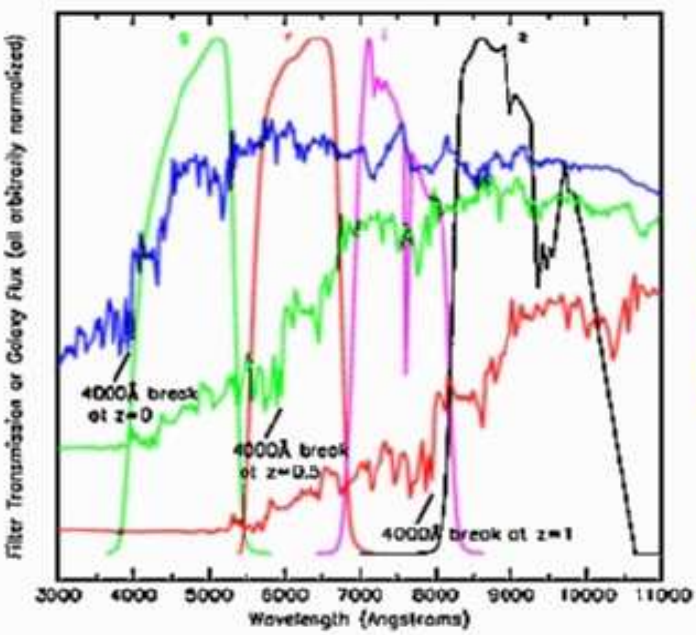

The 4000 A break in brightness seen through the different filters gives a measurement of the redshift

This is not as precise as full spectrum but it is **MUCH FASTER** and can go **FAINTER** (45 min for spectra; 100 sec for photo-z)

Covered Area: 5000 sq-degrees

Overlap with SPT SZ survey: SPT masses+DES redshifts. SDSS stripe 82 provides photo-z calibration spectra

2 tilings of the full area per year per filter

1 tiling

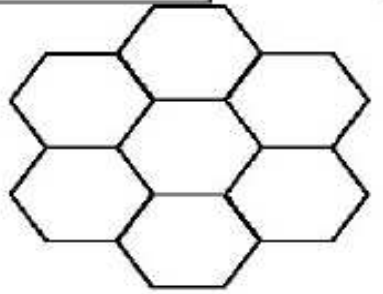

2 tilings

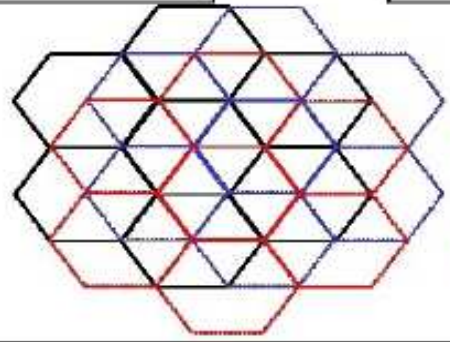

3 tilings

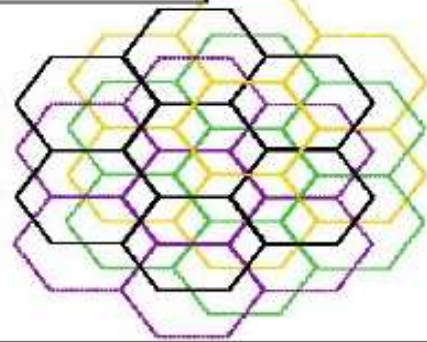

Support acquisition and reliable transfer of 300 GB/night on 500 nights over 5 years from CTIO (Chile) to NCSA (Illinois)

Maintain DES archive over the long term ( $\sim 1$  PB data at the end of the survey)





# The Dark Energy Survey: The Collaboration

Fermilab

U. Illinois at Urbana-Champaign

U. Chicago

LBL

U. Michigan

NOAO/CTIO

U. Pennsylvania

U. Ohio State

Argonne National Laboratory

**Brazil Consortium:**

Observatorio Nacional,

Centro Brasileiro de Pesquisas Físicas,

U. Federal do Rio de Janeiro,

U. Federal do Rio Grande do Sul

**UK Consortium:**

U. College London,

U. Cambridge,

U. Edinburgh,

U. Portsmouth,

U. Sussex

**Spanish Consortium:**

ICE/IEEC,

IFAE,

CIEMAT

**19 Institutions**

**~100 members**

**(+ technical staff +students)**

Spokesperson:

**JOHN PEOPLES (Fermilab)**



# The Dark Energy Survey: Timetable

## 2007-2008: Design and R&D

CCDs: Testing and packing. Develop characterization procedure

OPTICS: Lens polishing, assembly and alignment

ELECTRONICS: Final design and production

## 2008-2010: Construction

Selection of final high quality CCDs

Tests of the full camera

End optics

## Summer 2010: Transport full instrument to Chile

## Fall 2010: Start data taking

## 2010-2015: SURVEY!

# The PAU (Physics of the Accelerating Universe) Project

---

- **Approved project in the spanish plan “consolider-ingenio” 2010. The goal is to develop a competitive project to study the existence and nature of the dark energy**
  - **Use the BAO signature as main line**
  - **Build a CCD camera of large field of view and able to measure photometric redshifts with high precision using a new technique: A large number of very narrow optical filters**
  - **Install the camera in a telescope of 2.5 m class to perform a survey of 8000 sq-deg with redshifts between 0.1 and 1.0**
- 
- **The team is formed by particle physicists (both experimentalists and theorists), astronomers and astrophysicists.**



# The PAU Project

## Photometric redshift. vs. Spectroscopic redshift

**Photo-z:** Robust and complete, but not very precise. It can be measured for every object in the field of view..

**Spec-z :** Extremely precise, but incomplete. Limited by the number of fibers to  $\sim 1000$  objects in the field of view.

## NEW IDEA OF PAU: Combine the advantages of both techniques

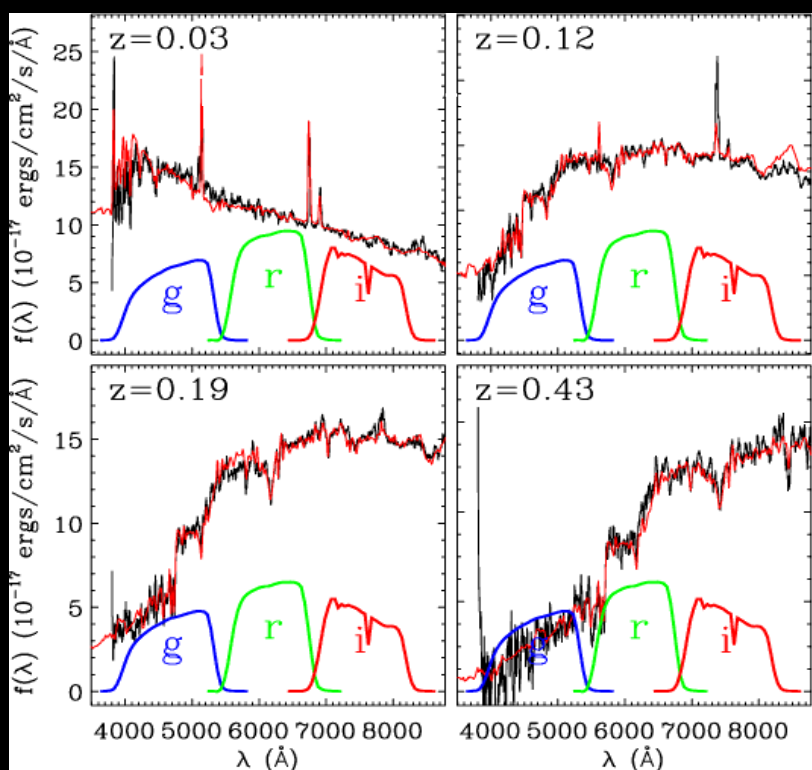

PAU photo-z ( $\sim 50$  filters)

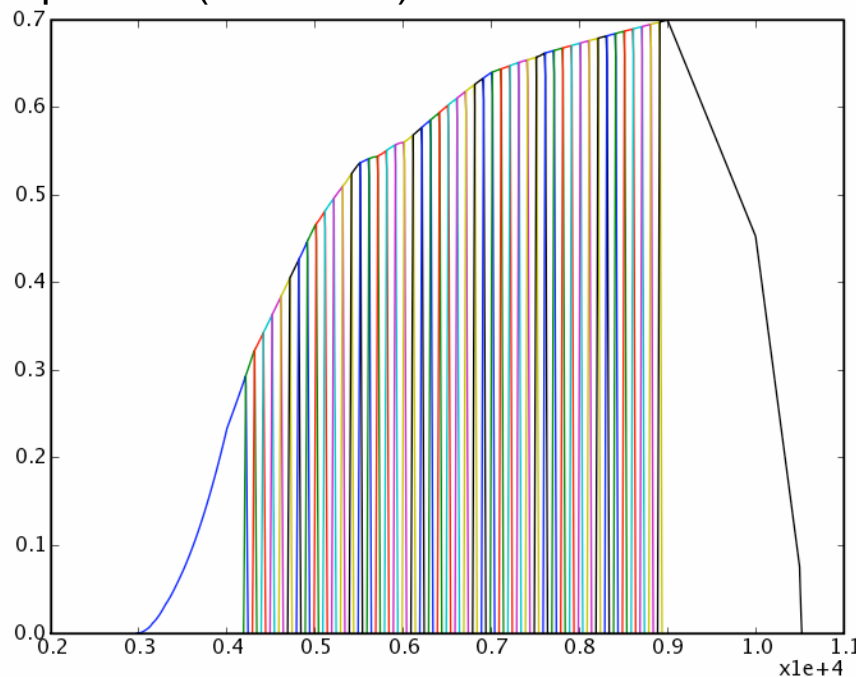

Using many narrow filters it is possible to measure precise redshift for a large amount of objects

# The PAU Project

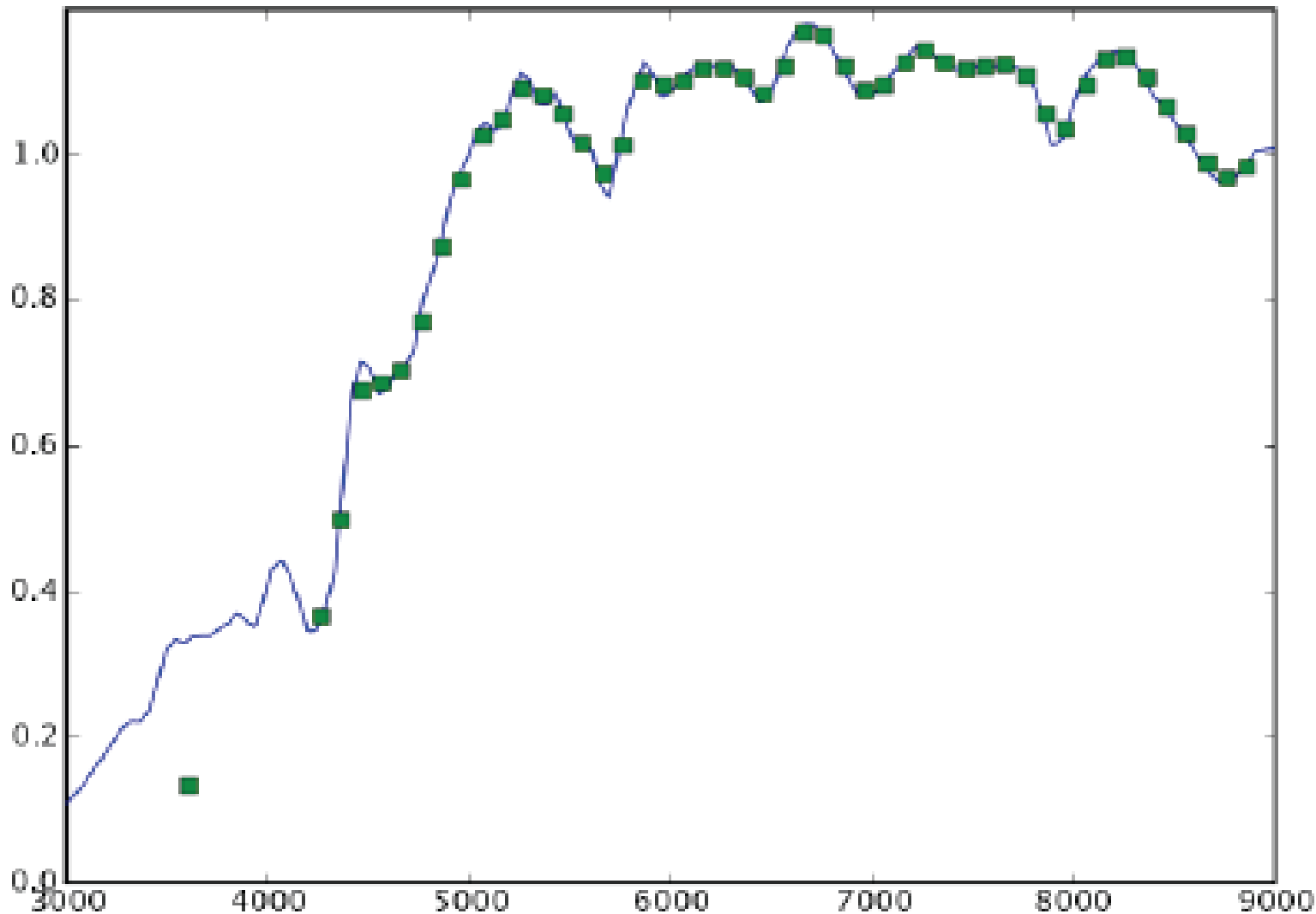

**The narrow filters technique, a low resolution spectrum is measured. It allows to determine the redshift with high precision and to study BAO both along the line of sight and perpendicular to the line of sight**

- Use early type galaxies (LRG) con  $L > L^*$
- $\Delta z / (1+z) < 0.003$

# The PAU Project

---

General requirements for PAUCam (still in design phase):

- **FoV  $\sim 6$  sq-deg**
- **Filter width  $\sim 100 \text{ \AA}$**
- **N. Filters  $\sim 44$**
- **Wavelengths in 350-1000 nm**
- **$0.4''$ /pixel**
- **Pixel size :  $15 \mu\text{m}$**
- **Intrinsic PSF  $\sim 0.4''$  FWHM**
- **50-80 CCDs (very likely similar to DES)**

**A dedicated 2.5m-class telescope will be used.**

Expected date for the starting of the survey is 2011

Expected precision in the determination of  $w$  using BAO is 2%

## Conclusions

**The ambitious goal of determining the nature of dark energy will have in the near future an important boost**

**Four techniques are identified as the most sensitive: SNeIa, BAO, galaxy clusters counts and weak gravitational lensing, although there are some other techniques to study dark energy**

**The final sensitivity will be limited by the systematic uncertainties**

**This is an exciting and probably very important question, both for astrophysics and for fundamental physics**